

# **ESTABLISHING A MASS CASUALTY MANAGEMENT SYSTEM**



**Pan American Health Organization**  
**Pan American Sanitary Bureau, Regional Office of the**  
**World Health Organization**



**Washington, D.C., 2001**

Also published in Spanish with the title:  
*Establecimiento de un sistema de atención de víctimas en masa*

**PAHO Cataloguing-in-Publication**

Pan American Health Organization  
Establishing a mass casualty management system  
Washington, D.C.: PAHO, ©2001.  
58 p.

ISBN 92 75 12346 2

**I. title**

1. DISASTER PLANNING
2. DISASTER EMERGENCIES
3. EVACUATION
4. RISK ASSESSMENT

NLM WX215.P187 2001

© Pan American Health Organization, 1995  
Reprinted, 2001

A publication of the Emergency Preparedness and Disaster Relief Coordination Program, PAHO/WHO.

The views expressed, the recommendations formulated, and the designations employed in this publication do not necessarily reflect the current policies or opinions of the Pan American Health Organization or of its Member States.

The Pan American Health Organization welcomes requests for permission to reproduce or translate, in part or in full this publication. Applications and inquiries should be addressed to the Program on Emergency Preparedness and Disaster Relief, Pan American Health Organization, 525 Twenty-third Street, N.W., Washington, D.C. 20037, USA; fax (202) 775-4578; e-mail: [disaster-publications@paho.org](mailto:disaster-publications@paho.org).

The production of this publication has been made possible through the financial support of the International Humanitarian Assistance Division of the Canadian International Development Agency (IHA/CIDA), the Office of Foreign Disaster Assistance of the U.S. Agency for International Development (OFDA/AID), the Department for International Development of the U.K. (DFID), and the French Ministry of Cooperation and Cultural Affairs.

---

# PREFACE

When an accident or disaster involving large numbers of injuries occurs, the first to provide emergency assistance are communities closest to the site of the incident. During the last 20 years the Caribbean and Latin America have given special attention to training emergency personnel in triage and in providing first aid either at the site of an accident or disaster, or at the hospital. The entire Region is now familiar with methods of classifying casualties, and this process has proved to be the most efficient means of ensuring survival of the injured in a mass casualty situation. However, there are still serious gaps in the coordination process, a situation that is most pronounced in remote areas or those with limited resources.

Many lives have been lost in mass casualty situations because resources were not mobilized efficiently. The challenge we face is this: the more scarce the resources, the more efficient the organization must be. This publication describes the steps to designing a mass casualty management system that will ensure the highest possible survival rate. It focuses on the involvement of police, firefighters, Red Cross volunteers, health center and hospital staff. If these professionals form part of the structure that we refer to as the mass casualty management "system" in this publication, they can positively contribute to saving lives.

We hope that this publication will provide the necessary information to guide disaster managers and health care professionals in establishing or reviewing their own mass casualty management system.

George A. O. Alleyne  
Director,  
Pan American Health Organization

---

# CONTENTS

PREFACE . . . . .	iii
ACKNOWLEDGEMENTS . . . . .	vi
1. INTRODUCTION . . . . .	1
A. DIFFERENT APPROACHES TO MASS CASUALTY INCIDENTS . . . . .	1
1. <i>Basic Approach</i> . . . . .	1
2. <i>Classical Care Approach</i> . . . . .	1
3. <i>Mass Casualty Management Approach</i> . . . . .	1
B. PROBLEMS IN DEVELOPING MASS CASUALTY MANAGEMENT . . . . .	1
1. <i>Limited Human Resources</i> . . . . .	1
2. <i>Limited Material Resources</i> . . . . .	2
3. <i>Poor Communications</i> . . . . .	2
C. OBJECTIVES OF THIS MANUAL . . . . .	2
2. DEFINITIONS . . . . .	3
1. <i>Mass Casualty Incident</i> . . . . .	3
2. <i>Emergency Services</i> . . . . .	3
3. <i>Health Care Services</i> . . . . .	3
4. <i>Mass Casualty Management</i> . . . . .	3
5. <i>Mass Casualty Management System</i> . . . . .	3
6. <i>Rescue Chain</i> . . . . .	3
3. FIELD MANAGEMENT . . . . .	6
A. DEFINITION . . . . .	6
B. FIELD ORGANIZATION . . . . .	6
1. <i>Alerting Process</i> . . . . .	6
2. <i>Pre-Identification of Field Areas</i> . . . . .	7
3. <i>Safety</i> . . . . .	7
4. <i>Security Measures</i> . . . . .	9
5. <i>Command Post</i> . . . . .	9
C. MANAGEMENT OF VICTIMS . . . . .	13
1. <i>Search and Rescue</i> . . . . .	13
2. <i>Field Care</i> . . . . .	13
3. <i>Evacuation Management Center (EMC)</i> . . . . .	27
D. FIELD MANAGEMENT PLAN . . . . .	27
4. TRANSFER ORGANIZATION . . . . .	29
A. DEFINITION . . . . .	29
B. PREPARATION FOR EVACUATION . . . . .	29
1. <i>General Procedures</i> . . . . .	29
2. <i>Preparation for Transport</i> . . . . .	29
C. EVACUATION PROCEDURES . . . . .	30
1. <i>Regulation of Evacuation</i> . . . . .	30
2. <i>Control of Victim Flow</i> . . . . .	30
D. EVACUATION OF NON-ACUTE VICTIMS . . . . .	32
E. CASE STUDY . . . . .	32

---

5. HOSPITAL ORGANIZATION .....	35
A. INTRODUCTION .....	35
B. ACTIVATION OF HOSPITAL MASS CASUALTY MANAGEMENT PLAN .....	35
1. <i>Alerting Process</i> .....	35
2. <i>Mobilization</i> .....	35
3. <i>Hospital Command Post</i> .....	37
4. <i>Clearance of Receiving Facility</i> .....	37
5. <i>Estimate of Hospital Care Capacity</i> .....	37
C. RECEPTION OF VICTIMS .....	37
1. <i>Location</i> .....	37
2. <i>Personnel</i> .....	39
3. <i>Links with the Field</i> .....	39
D. HOSPITAL TREATMENT AREAS .....	39
1. <i>Red Treatment Area</i> .....	39
2. <i>Yellow Treatment Area</i> .....	39
3. <i>Green Treatment Area</i> .....	39
4. <i>Hopeless Victim Area</i> .....	41
5. <i>Deceased (Black Category) Victims Area</i> .....	41
E. SECONDARY EVACUATION .....	41
F. CASE STUDY (Continued) .....	41
G. HOSPITAL MANAGEMENT GENERAL SCHEME .....	42
6. NATIONAL MASS CASUALTY MANAGEMENT PLAN .....	44
A. NATIONAL RESPONSE TO MASS CASUALTY EVENTS .....	44
B. DISTRICT RESPONSE TO MASS CASUALTY EVENTS .....	44
7. ASSISTANCE FROM NEIGHBORING COUNTRIES OR TERRITORIES .....	45
A. MOBILIZATION .....	45
B. INTEGRATION OF EXTERNAL STAFF .....	45
8. IMPLEMENTATION OF A MASS CASUALTY MANAGEMENT SYSTEM .....	46
A. PHASE 1 - ADOPTION AS NATIONAL POLICY .....	46
B. PHASE 2 - SENSITIZATION .....	46
1. <i>National Consultation</i> .....	46
2. <i>Sectoral Consultation</i> .....	46
3. <i>Multisectoral Consultation</i> .....	46
4. <i>Community Sensitization</i> .....	46
C. PHASE 3 - TRAINING .....	47
D. INSTITUTIONALIZATION OF THE SYSTEM .....	47
1. <i>National Emergency Act</i> .....	47
2. <i>Job Description</i> .....	47
3. <i>Training</i> .....	47
E. MAINTENANCE OF A MASS CASUALTY MANAGEMENT SYSTEM .....	47
ANNEX 1 - Action Cards .....	49
ANNEX 2 - Standard Job Profiles .....	55
BIBLIOGRAPHY .....	58

---

---

# ACKNOWLEDGEMENTS

The Pan American Health Organization would like to thank the principle author of this publication, Dr. Jean Louis Bordonado, who worked in collaboration with Drs. Carissa Etienne, Michael Brown, and Jean Luc Poncelet. Acknowledgement is also given to Drs. Raul Morales, Winsome Segree, Roslyn Bascombe-Adams, Carlos Bonilla, Robert Margulies, Raana P. Naidu and Jorge Grande, who reviewed draft versions of this publication and provided valuable comments.

---

# I. INTRODUCTION

## A. DIFFERENT APPROACHES TO MASS CASUALTY INCIDENTS

### 1. Basic Approach

A “scoop and run” method is used most commonly to deal with accident victims. This approach does not require specific technical ability from the rescuers. While this method can be justified for the management of small numbers of victims in certain circumstances (e.g., when an accident occurs in the immediate proximity of available emergency care services), the same approach in a mass casualty situation will result in the transfer of the problem from the incident site to the hospital, overwhelming and disrupting the care capacity of the health facility.

### 2. Classical Care Approach

In the “classical care approach”, first responders are trained to provide victims with basic triage and field care before evacuation to the nearest available receiving health care facility.

This approach juxtaposes two organizations that are working independently with only weak linkages:

- *The field organization* (often involving non-health sector responders), and
- *The receiving health care organization* which is often totally divorced from the pre-hospital problem.

In a mass casualty situation, this approach will quickly result in chaos.

### 3. Mass Casualty Management Approach

Mass casualty management, the most sophisticated approach, includes pre-established procedures for resource mobilization, field management and hospital reception. It is based on specific training of various level of responders and incorporates links between field and health care facilities through a command post. It acknowledges the need for a multi-sectoral response for triage, field stabilization and evacuation to adapted health care facilities. The development of this approach was based on the availability of large amounts of human and material resources (“adequate manpower and equipment”).

Attempting to replicate this approach in a country with limited resources does not result in the expected level of effectiveness. In such situations, the mass casualty management approach should be adapted with special attention given to a country’s specific situational problems.

## B. PROBLEMS IN DEVELOPING MASS CASUALTY MANAGEMENT

### 1. Limited Human Resources

Due to a shortage of human resources, a country will experience difficulties in developing, training and maintaining specialized personnel. Since staff are fully occupied with daily routine tasks, it will be difficult to develop a mass casualty management approach with staff exclusively reserved for

emergency management. These countries, therefore, must either persist at a lower level of organization or they are forced to "import" a non-adapted organization.

## 2. Limited Material Resources

- 1) One secondary/tertiary hospital for an area
- 2) Minimal transport resources (ambulances)
- 3) Lack of radiocommunications

The three conditions listed above will prevent a smooth and well-coordinated dispatch of victims of a mass casualty incident to various health care facilities. Rescuers will be obliged to carry all victims to the only care facility available, which may overwhelm the health care system.

## 3. Poor Communications

### *Topography*

Access to a mass casualty incident site will be hindered by difficult topography. Road evacuation of victims is difficult in mountainous areas, particularly in developing countries. This delays the arrival of the victims to the care facilities. Moreover, the transportation of patients under difficult conditions will have a negative impact on the patients' status.

Certain types of topography will also result in problems with radio-communication, a basic requirement for the organization of rescue.

### *Isolation*

External assistance will have difficulty reaching isolated areas. This isolation can be permanent (for example in the case of islands, remote mountain areas, or forest set-

tlements) or temporary (after floods, landslides, snow, or bridge collapse).

The disaster response plan in these areas must take into consideration the fact that they can stay isolated for extended periods. This dimension must be included in any mass casualty approach.

## C. OBJECTIVES OF THIS MANUAL

"Specific problems require specific solutions" is an understatement. When resources are limited, as outlined above, it is necessary to develop a mass casualty management approach that encompasses the limitations imposed by actual circumstances. The organization implemented must allow an effective transition from good daily rescue and care procedures to mass casualty management, maximizing the use of limited existing resources. The development of such a set of connected parts functioning together for a particular goal will constitute a Mass Casualty Management System.

The objective of this manual is to provide the necessary guidelines to assist senior emergency personnel in establishing a Mass Casualty Management System based on:

- Good daily emergency services;
  - Good daily coordination procedures;
  - Fast and efficient transition from routine procedures to mass casualty management;
  - Well-established mass casualty management procedures.
-



---

## 2. DEFINITIONS

### A. DEFINITIONS

#### 1. Mass Casualty Incident

Any event resulting in a number of victims large enough to disrupt the normal course of emergency and health care services.

#### 2. Emergency Services

Those services which are specifically designed to respond on a daily basis to emergency situations: Police, Fire Service, Ambulance Service, Accident and Emergency Department.

#### 3. Health Care Services

All services which are providing health care to any kind of patient: Hospital, Polyclinic, Health Center/Clinic, Ambulance Service. In many countries, these services are regulated by the Ministry of Health.

#### 4. Mass Casualty Management

Management of victims of a mass casualty event, aimed at minimizing loss of life and disabilities.

#### 5. Mass Casualty Management System

The group of units, organizations and sectors which work jointly, through institutionalized procedures, to minimize disabilities and loss of life in a mass casualty event

through the efficient use of all existing resources.

The Mass Casualty Management System is based on:

- Pre-established procedures, to be used in daily emergency activities and to be adapted to meet demands of a major incident;
- Maximization of the use of existing resources;
- Multi-sectoral preparation and response;
- Strong pre-planned and tested coordination.

This System is developed in order to:

- Accelerate and amplify daily procedures in order to maximize the use of the existing resources;
- Establish a coordinated multi-sectoral rescue chain;
- Promptly and efficiently bring disrupted emergency and health care services back to routine operation.

#### 6. Rescue Chain

The Rescue Chain, the essence of the Mass Casualty Management System, involves the Ministry of Health, private hospitals, police, fire service, NGOs, transport services, and communications (see Figure 1).

This chain starts at the disaster site (with activities like initial assessment, command and control, search and rescue, field care), continues with transfer of victims to adapted

**FIGURE I. MASS CASUALTY MANAGEMENT SYSTEM  
A Multi-Sectoral Rescue Chain**

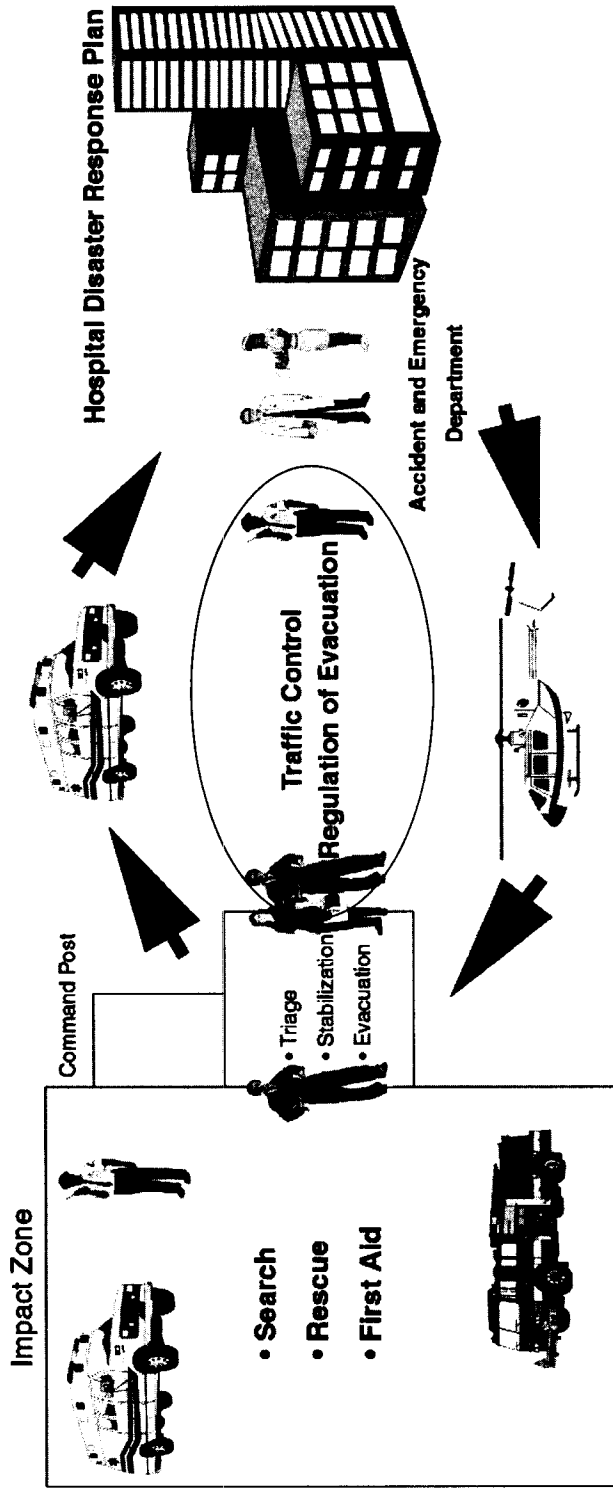

PRE-HOSPITAL ORGANIZATION

HOSPITAL ORGANIZATION

facilities (using procedures for regulation of evacuation and ambulance traffic control), passes through hospital reception (with activation of the hospital disaster response plan), and ends only when the victims have received all emergency care needed to stabilize them.

The implementation of this Rescue Chain requires the existence of:

- An efficient Accident and Emergency Department;
- A basic radiocommunications network
- Coordination procedures among all sectors involved;
- Skilled multi-sectoral rescue teams.

As in any chain, the strength and reliability of the system depends on that of each link; if one fails, the entire system will be compromised.

---

---

# 3. FIELD MANAGEMENT

## A. DEFINITION

---

Field management encompasses procedures used to organize the disaster area in order to facilitate the management of victims.

## B. FIELD ORGANIZATION

---

### 1. Alerting Process

#### *1.1 Definition*

The alerting process is a sequence of activities implemented to achieve the efficient mobilization of adequate resources. This includes initial warning, assessment of the situation, and dissemination of the alert message.

#### *1.2 Purpose*

- To confirm the initial warning;
- To evaluate the extent of the problem;
- To ensure that appropriate resources are informed and mobilized.

#### *1.3 Dispatch Center*

The core of the alerting process is the dispatch center: a communications center that receives all warning messages and is linked by radio and phone to all services involved in emergency management (e.g., "911").

The dispatch center must have the capacity to mobilize a small assessment team ("flying team"), composed of personnel from police, fire, or ambulance services, in

order to confirm a warning message when necessary.

#### *1.4 Confirmation of Initial Warning*

##### *1.4.1 Warning message from general public*

This message, issued by a non-qualified observer, must be confirmed, either by immediate call-back or by a second identical message from another source.

If this is not immediately possible, the dispatch center must send a "flying team" to the site, while alerting potential responders (stand-by alerting process).

##### *1.4.2 Warning message from qualified observer*

Upon reception of a message from an individual working in emergency services and experienced in initial assessment, appropriate resources can be immediately dispatched.

#### *1.5 Initial Assessment*

##### *1.5.1 Definition*

The initial assessment is the procedure used to identify the immediate extent and the potential risk of the problem.

##### *1.5.2 Purpose*

- To know exactly what is happening and what could happen;
- To mobilize adequate resources;
- To correctly organize the field management.

### 1.5.3 Personnel

Any first responder trained in initial assessment will be appropriate to carry out this procedure.

### 1.5.4 Occasion

Any accident should benefit from an initial assessment. Any major incident needs immediate initial assessment.

### 1.5.5 Method

Initial assessment is a sequence of activities identifying the following:

- Precise location of event;
- Time of the event;
- Type of incident;
- Estimate of number of casualties;
- Added potential risk;
- Exposed population.

### 1.6 Report to Central Level

The initial assessment must be reported immediately to the dispatch center before any further action is taken. If the first responders start their work in the field before reporting, there will be a delay in mobilization of resources, or critical information may be lost if responders are trapped in a second accident.

### 1.7 Dissemination of Information

As soon as the warning message is confirmed, the dispatch center will issue the alert message, mobilizing necessary resources and informing specific persons and institutions.

This alert message must be rapidly circulated using pre-established procedures, such

as a cascade phone system (see Figure 2).

## 2. Pre-Identification of Field Areas

The second role of the initial assessment team is to identify the field areas to be established. These will include:

- Impact Zone;
- Command Post Area;
- Advance Medical Post Area;
- Evacuation Area;
- VIP and Press Area;
- Access Roads.

Pre-identification of field areas will allow various incoming resources to reach their specific areas rapidly and efficiently. It constitutes the initial part of the on-site deployment.

One of the best ways to realize and present this pre-identification is to draw a simple map of the area, including the main topographical and physical features such as roads, natural/artificial boundaries, ponds, rivers, buildings, etc.

Using this map, potential risk areas, victims, access roads and the various field areas can be identified, including the boundaries of restricted areas.

Compass rose and wind direction must also be provided.

## 3. Safety

### 3.1 Definition

Safety measures are implemented to protect victims, responders and exposed population from immediate and/or potential risk (extension of the accident, responding to traffic accidents, hazardous materials, etc.).

---

FIGURE 2. CASCADE PHONE SYSTEM

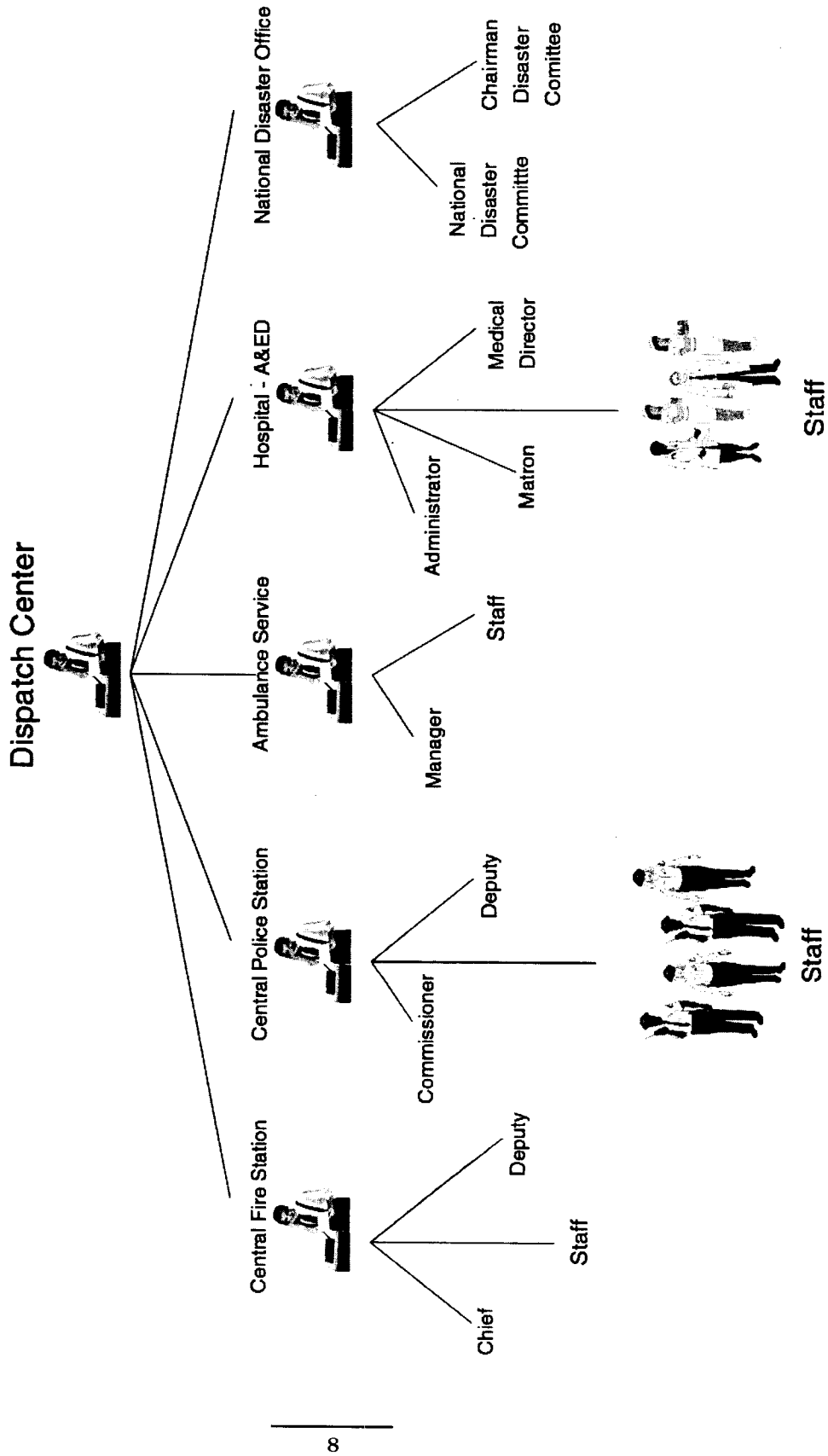

### 3.2 Safety Measures

**3.2.1 Direct action** includes risk reduction by fire fighting, confinement of hazardous material, use of protective clothing, and evacuation of exposed populations.

**3.2.2 Preventive actions** include the establishment of the following restricted areas:

- The impact zone—strictly restricted to professional rescuers; adequately equipped.
- Secondary area—restricted to authorized staff working in rescue operation, care delivery, command and control, communications, ambulance services, security/safety. The Command Post, the Advance Medical Post, the evacuation center and parking for the various emergency and technical vehicles will be set up in this area.
- The tertiary area is to be accessed by press officials and to act as a “buffer” zone to keep onlookers out of danger.

The size and design of the restricted areas depend upon the type of accident (toxic smoke, hazardous materials, intense fire, explosion risk), the wind and topography (see Figures 3–4).

### 3.3 Personnel

Safety measures will be implemented by the fire services, assisted in specific problems by specialized units (hazardous material, explosives experts, etc.). Restricted areas will be defined by fire services in coordination with specific services (for example, the airport manager, chemical plant’s chief of security) when necessary.

### 4. Security Measures

Security measures are implemented to keep external elements from interfering with the rescue organization. Restricted access of each safety area is maintained by implementing crowd and traffic control.

Security measures contribute to safety by:

- Protecting workers from external influences (additional stress);
- Avoiding obstruction of flow of victims and rescue resources;
- Protecting the general public from exposure to risk.

Security is ensured by police force, special units (defense force, national guard), government security officers, airport security, and hospital security.

### 5. Command Post

#### 5.1 Definition

The command post is a multi-sectoral control unit established to:

- Coordinate the various sectors involved in field management;
- Link with back-up systems to provide information and mobilize necessary resources;
- Supervise victim management.

This will only be possible if the command post has a comprehensive radio network.

#### 5.2 Purpose

The field management of a disaster requires the mobilization and coordination of sectors which do not routinely work together. The efficiency of pre-hospital activities requires strong coordination of the various responders. In order to fulfil this need for coordination, the command post must be set up at the very beginning of the rescue operation.

**FIGURE 3. RESTRICTED AREAS**  
**Road Traffic Accident**

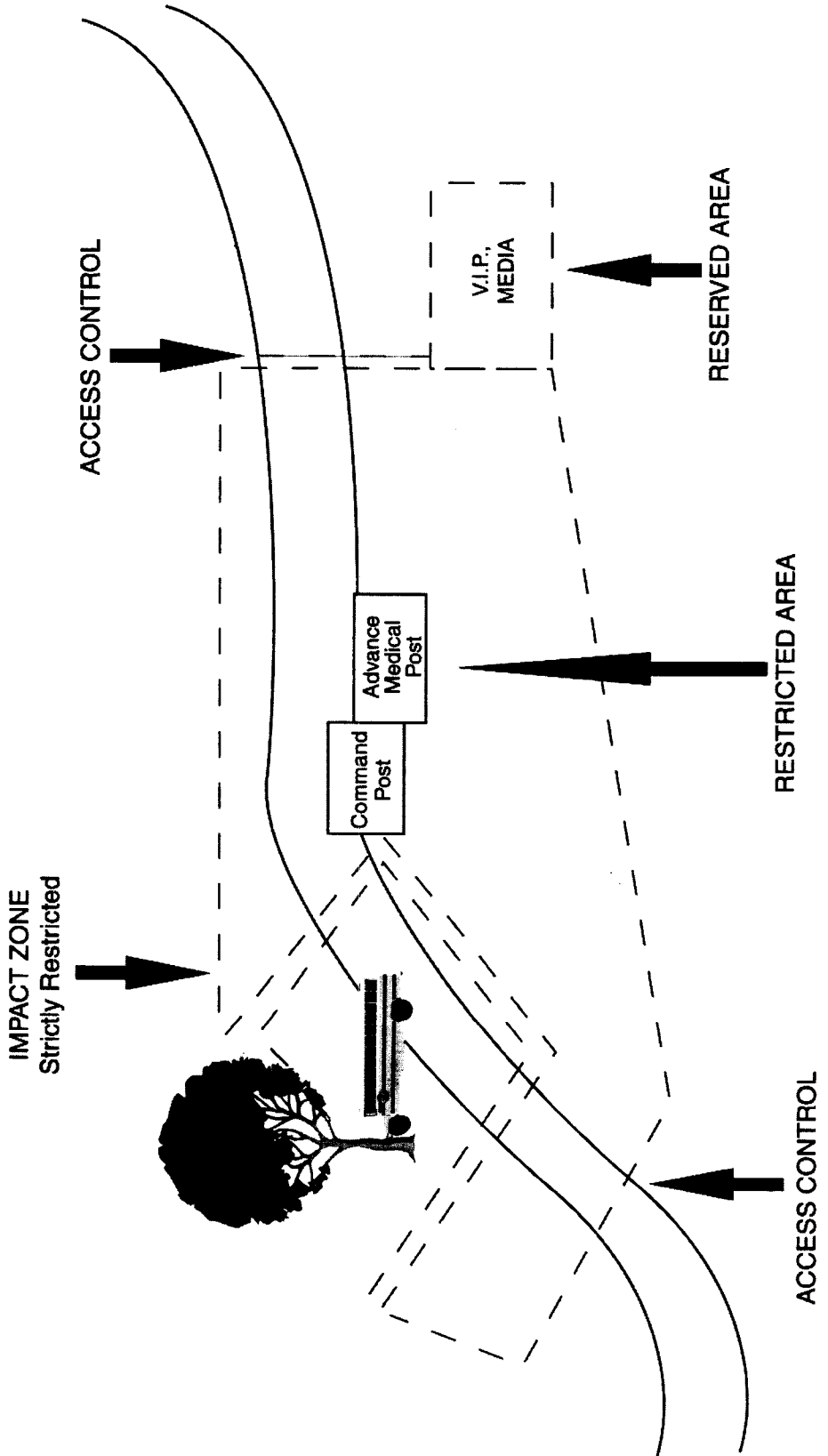



**FIGURE 4. RESTRICTED AREAS**

**Chemical Fire**

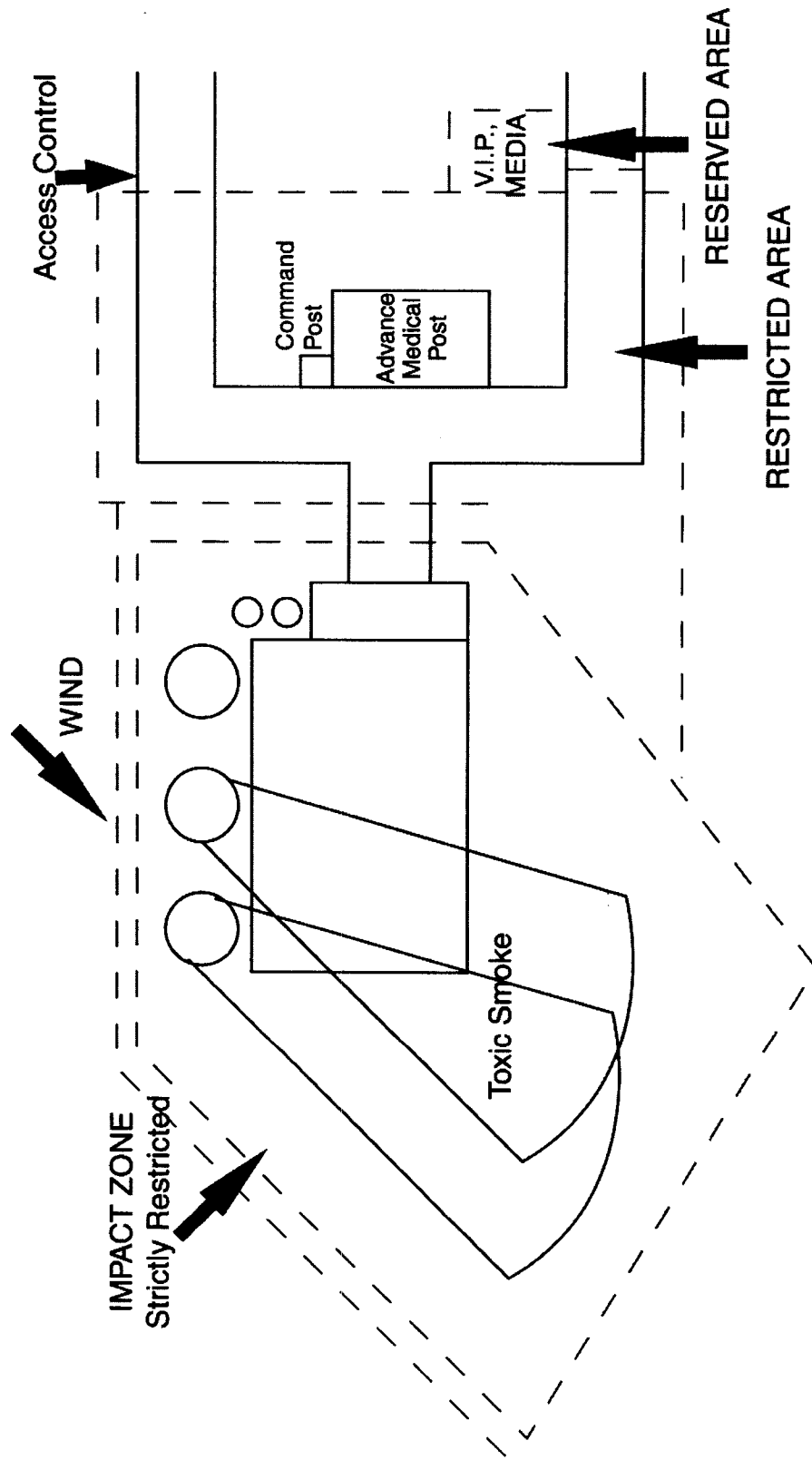

### 5.3 Location

The main criterion for an effective command post is radiocommunications. This can be implemented from any sort of structure, ranging from a single police car to a specific mobile command post, or from a tent to an appropriately located building.

The command post must be installed at the external boundary of the strictly restricted area (impact zone), close to the advance medical post and the evacuation area. It must be easily identified and accessible. Its location should accommodate all communication (visual, radio, road).

### 5.4 Personnel

The command post is staffed by the highest ranking personnel available from police, fire service, health sector, and defense force (where existing).

This core group can co-opt volunteer organization representatives and, depending on the type of accident, specialized personnel (e.g., airport manager in the case of an airplane crash, prison governor in prison incident).

It is generally agreed that the coordinator of this unit is a police officer. However, depending on the specific nature of the incident, the coordinator may be more specialized (e.g., an airport manager in case of an airport accident).

Those likely to operate in the command post must be identified by name and position. They must be familiar with each other's roles, know each other, and have practiced and discussed issues during regular meetings. These meetings should include exercises to practice coordination of resources, and administrative discussions about changes in resources or procedures as they

develop. Meetings should be held on a regular basis, but they need not be frequent.

### 5.5 Method

The command post is the communication/coordination hub of the pre-hospital organization. The command post will, by constant reassessment of a situation, identify needs to increase or decrease resources in order to:

- Release, as soon as the situation allows, the emergency services staff that are no longer needed in the field. In this way, the command post will contribute to the re-establishment of routine operations.
  - Organize the timely rotation of rescue teams exposed to stressful/exhausting situations in close cooperation with the back-up system.
  - Ensure the provision of adequate supplies of equipment and manpower.
  - Ensure comfort/welfare of rescue teams (provide food and drink).
  - Provide information to back-up systems, and keep other officials and the media informed (through an official spokesperson).
  - Determine the termination of field operations.
-

## C. MANAGEMENT OF VICTIMS

---

### 1. Search and Rescue

Search and rescue operations depend strictly on skilled teams from the fire service and specialized units, assisted when necessary by volunteers. These teams will:

- Locate victims;
- Remove victims from unsafe location to collecting point, if necessary;
- Assess victim status (on-site triage);
- Provide first aid, if necessary;
- Transfer victims to the advance medical post, if necessary.

Search and rescue teams work in the strictly restricted area (impact zone) under the command of a fire officer or, in specific situations, of specialized personnel.

Depending on the risk (e.g., toxic smoke, hazardous materials), rescue teams will utilize special protective clothing and equipment. In exhausting working conditions, a quick turnover of rescue teams must be implemented.

The situation could arise in which, due to the location of the victim (trapped under a collapsed wall, for example), extrication will need time. If the status of the victim is bad, the rescue team leader can request, through the Command Post, on-site assistance of medical personnel in order to commence stabilization of the patient during extrication. This procedure requires specifically trained medical personnel and must only be used in exceptional cases.

When the impact zone is large, it may be necessary to divide it into smaller "working areas", each assigned to a rescue team. In such a situation, or when the impact zone is unsafe, the Search and Rescue Officer will

establish a Collecting Point in a safer area adjacent to the impact zone, where victims will be temporarily assembled (see Figure 5). This collecting point will be managed by emergency medical technicians (EMTs) and volunteers, and will ensure the initial triage, first aid and transfer to the advance medical post.

### 2. Field Care

When an area does not have adequate health care facilities available to face a mass casualty incident (e.g., one small secondary/tertiary hospital), rapid transportation of all victims to a hospital with limited resources will compromise the care of the seriously injured victims. In addition, this will profoundly disrupt the hospital care system, endangering patients already in the hospital. It is not realistic to "push" 200 victims into a 300-bed hospital that has only three operating rooms, for example, and expect good results.

One operating theater requires at least six highly specialized people to run it. A patient suffering from "major" trauma may take 3-4 hours to "stabilize". Each region or area must identify its own resources and limitations:

- How many operating theaters are available in a region?
- How many of these operating theaters can be adequately staffed in a crisis?

The answer to the second question may affect the answer to the first.

In limited resource conditions, due to space and care available, transport of victims to hospital should be staggered. This supposes that victims will receive adequate field treatment, allowing them to tolerate this delay.

---

**FIGURE 5. COLLECTING POINT FOR VICTIMS**

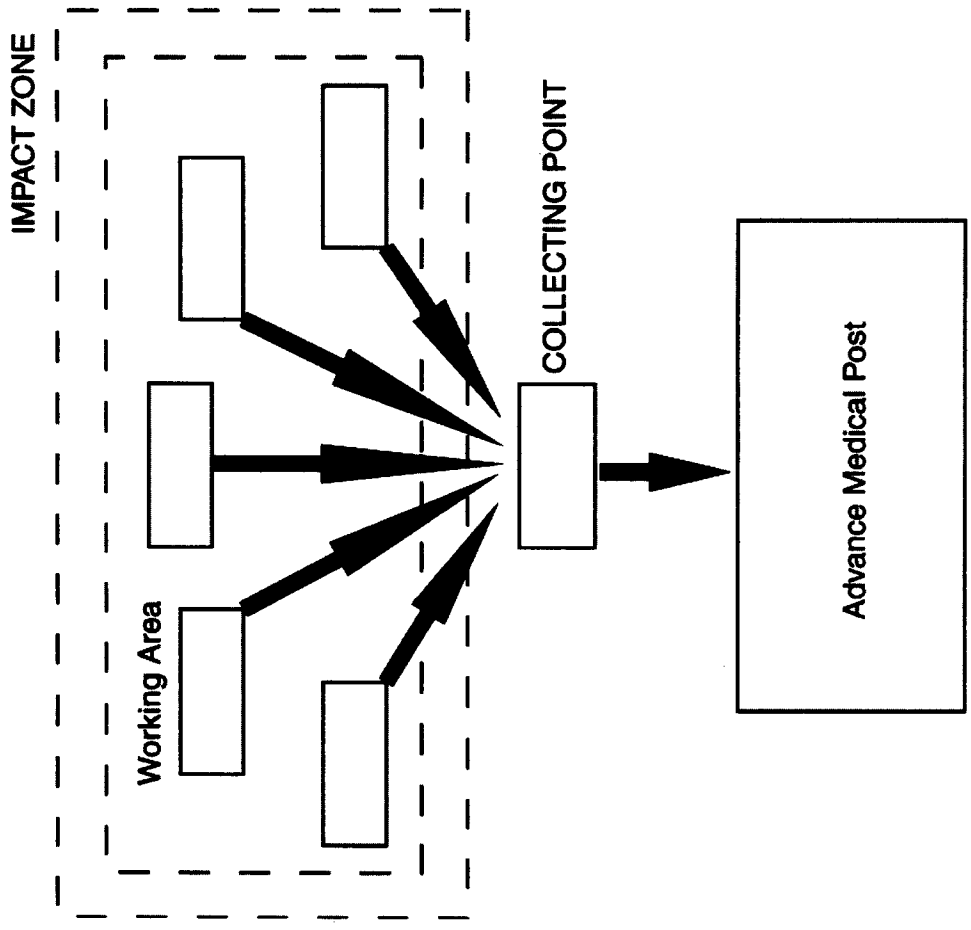

Actually, in a mass casualty event, only a small number of victims will need immediate treatment in a hospital. The “Golden Hour”, here, applies essentially to victims with internal bleeding who could fully benefit from immediate “life saving” surgery.

The recent progress in pre-hospital emergency medicine allows specific skilled teams to provide good field care, through establishment of an advance medical post. This “disaster field medical team” approach supposes the existence of:

- Good triage capacity;
- Specifically trained medical teams;
- Good radiocommunications between the field and the hospital;
- Good coordination of all involved sectors.

## 2.1 Triage

The objective of “classical” field triage is to identify victims needing immediate transport to health care facilities and those who can be delayed. This triage is based essentially on urgency (victim status), and, secondly, on likelihood of survival.

In countries or areas with few resources, this second criterion is of greater importance, being strictly correlated to the health care resources available. So a new triaging approach is necessary based on urgency, likelihood of survival, as well as on care resources available.

Triage objectives will then be:

- Quick identification of victims needing immediate stabilization (field medical care), and
- Identification of victims who could be saved only by immediate surgery (life-saving surgery).

The field triage process will be conducted at three levels:

- On-site triage (triage one);
- Medical triage (triage two);
- Evacuation triage (triage three).

### 2.1.1 On-Site Triage

This is the on-site categorization of victims “where they are lying” or at the collecting point. This on-site triage, due to limited medical resources, will generally be performed by first aiders, sometimes by EMTs.

A survey of 15 mass casualty simulation exercises conducted in the Caribbean area showed that when the color code triage is utilized, the percentage of incorrect classification decreased in accordance to experience (i.e., first aid workers made the most incorrect classifications followed by EMTs and then emergency medical staff; see Figure 6).

However, if we group red and yellow victims in an “acute victim” category and green in a “non-acute victim” category, the percentage of incorrect classifications is significantly lower (see Figure 7).

The result of this survey demonstrates that it is difficult for a volunteer/first aider, infrequently exposed to a triage situation, to accurately distinguish between some red and yellow victims, while his or her training will allow easier differentiation between acute and non-acute victims. Moreover, first aiders utilize more time to fill the color code triage tag, with less effectiveness, than more skilled personnel.

In spite of the remarkable commitment of volunteers, these problems will not be solved by more theoretical training, but only by greater exposure to real situations. This may be difficult to organize for volunteers who are not involved on a daily basis in emergency rescue operations.

**FIGURE 6. TRIAGE**  
**Percentage of Incorrect Categorization**

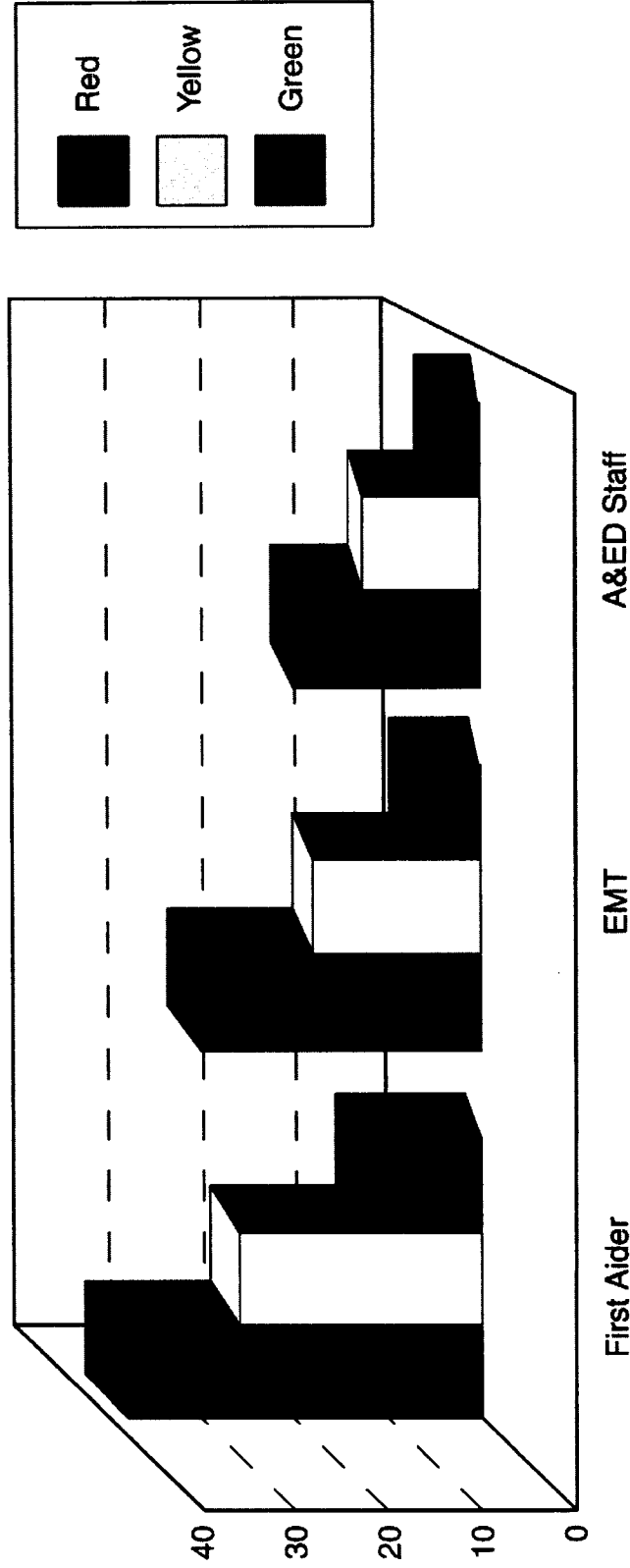

Average from 15 simulation exercises

# FIGURE 7. TRIAGE

## First Aider Level

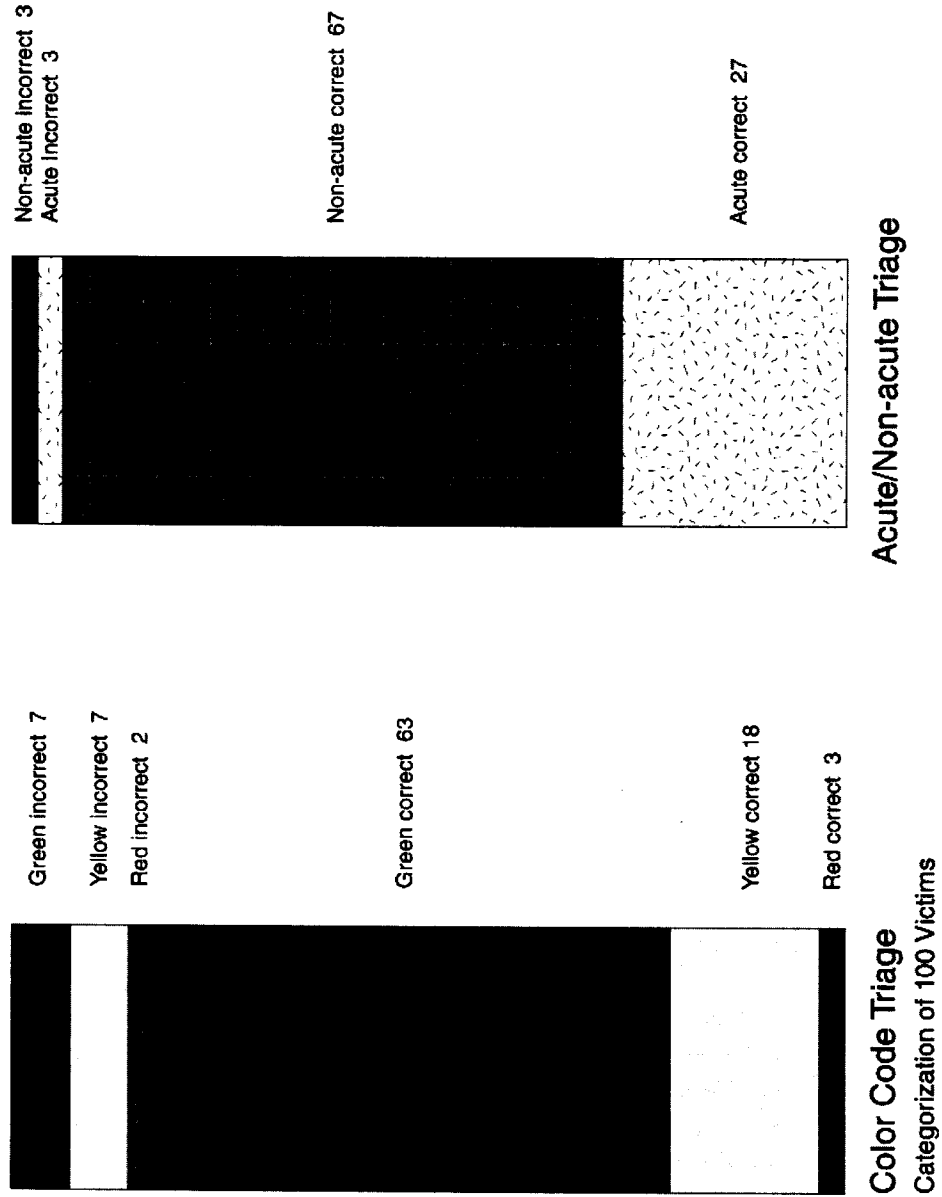

The on-site triage is expected to identify those victims needing prompt medical attention (quick transport to the advance medical post) and those who can wait; in other words, to classify victims in acute (red and yellow) and non-acute (green and black) categories.\*

Acute victims will not be tagged but marked by a large floating red ribbon, securely attached to them. Non-acute victims will be identified by a green ribbon. Stretcher bearers will thus easily identify, even from some distance, acute patients to be taken immediately to the Advance Medical Post.

In this way, on-site triage time (for assessing, categorizing, marking and transporting victims to the advance medical post) will be significantly reduced, and incorrect categorization will decrease.

### 2.1.2 Medical Triage

This triage will be performed at the entrance to the Advance Medical Post by the most experienced medical personnel available who have extensive skill in triaging.

Although most disasters produce injured victims, some specific events (e.g., mass food poisoning, chemical intoxication, shipwreck) give rise to victims needing only intensive care. Moreover, primary treatment for severe shock in multiple trauma is intensive resuscitation. Hence, when possible, the preferred specialist to act as triage officer should be an emergency physician, followed by an anesthesiologist, then by a surgeon.

The objective of medical triage is to determine the level of care needed. The color code triage tag will be utilized at this stage, when more accurate information on victim status can be collected. Accordingly, the color categories assigned to the victims will be:

*Red* = requires immediate stabilization care and includes victims with:

- Shock status from any cause;
- Respiratory distress;
- Head injury with unequal pupils;
- Major external bleeding.

This immediate care (intensive field care) provided to patients with a reasonable likelihood of surviving, will allow them to tolerate transfer to health care facilities and prepare them to receive treatment. It should also allow for the recategorization of victims from "red" status to "yellow" (e.g., chest drainage for a tension pneumothorax).

*Yellow* = requires close monitoring; care can be somewhat delayed. This category includes victims with:

- Risk of shock (e. g., heart attack, major abdominal trauma);
- Compound fractures;
- Femur/pelvic fracture;
- Severe burns;
- Unconscious/ head injury;
- Victim with uncertain status.

All these victims will receive an IV line (vein guard), close monitoring for any complication, and will receive treatment as soon as possible.

*Green* = requires delayed or no treatment, including victims with:

- Minor fracture;
- Minor wounds and burns.

These patients, after receiving dressing and/or splinting, will be transferred at the end of the field operation.

- Hopelessly injured victims, if still alive at the end of the field operation, will be transferred to health care facilities.

*Black* = Deceased

---

\* Note: Terms for triage categories vary. "Acute" is used for red and yellow categories and "non-acute" for green and black in this manual. Other common terms are "emergent" or "immediate" in the red category; "urgent" or "delayed" in the yellow category; "nonurgent," "minimal," or "ambulatory" are used for the green category; "expectant" is used for the black category.



Particular circumstances will dictate different responses: A victim with 50% body surface burns is classically triaged as “red”. In fact, the immediate treatment needed is essentially infusion. In an accident with a small number of victims and substantial care resources available, this person must receive immediate attention and be quickly transferred to a specialized care unit.

In a mass casualty event where there are limited care resources, the initial treatment of such a burn victim can be delayed for an hour as long as the victim has no breathing problems. Thus the immediate transfer to a hospital is no longer a priority. This victim will then be classified as “yellow”.

### 2.1.3 Evacuation Triage

This triage will prioritize victims for transfer to adapted and ready-to-receive health care facilities.

If the Advance Medical Post is successful in its care providing role, the number of “red” victims should decrease, and re-tagging will be necessary before evacuation.

The Medical Officer in charge of the Advance Medical Post will decide, according to the status of the victims and in liaison with the Command Post and the hospital, who will be moved first to what destination, with what type of vehicle and escort.

The color code triage will be used as follows:

**Red** = to be transferred immediately or as soon as possible to tertiary hospital, by equipped ambulance, with medical escort. This includes:

- Victims needing life-saving surgery;
- Victims needing function-saving surgery;
- Victims for ICU.

**Yellow** = to be transferred, after evacuation of all red victims, to tertiary hospital, by ambulance, with first aider escort. This includes:

- Victims without life threatening problems needing tertiary hospital care.

**Green** = to be transferred, at the end of the field operations, to appropriate health care facilities by available vehicles, without escort. This includes:

- Minor wounds and burns → health center or polyclinic, never to main hospital;
- Hopelessly injured → main hospital.

**Black** = transfer to morgue.

## 2.2 First Aid

### 2.2.1 Personnel

First aid is provided by volunteers, fire and police staff, special unit staff, EMTs and medical personnel.

### 2.2.2 Location of first aid

- Directly on-site, before moving victim;
- At the collecting point;
- In the “Green Area” of the Advance Medical Post;
- In the ambulance while transferring victims to health care facilities.

### 2.2.3 Action

Classical first aid attention can be provided, including control of airways, breathing and cardiac functions, position of victim, control of bleeding, immobilization of fracture, dressing and comfort. However, first aiders must keep in mind that, on-site, the most important priority is to transfer, as

soon as possible, acute victims to the advance medical post while ensuring key first aid actions (i.e., maintain airways, control bleeding). Since it is time and manpower consuming, CPR must never be used on site in a mass casualty event.

### *2.3 Advance Medical Post (AMP)*

#### *2.3.1 Purpose*

One of the main objectives of rescue and care services in a mass casualty event is to reduce loss of life by providing, as soon as possible, effective care for all the victims. When, due to limited resources and lack of space, a health care facility cannot provide adequate housing and effective treatment for victims of a mass casualty event, alternative solutions must be proposed. Distributing victims among various health institutions is a viable alternative, but this supposes the existence of other health facilities at a reasonable distance from the disaster or accident site and the availability of transport resources and coordination.

If distance is too great, or transport resources too few, the transfer of victims to an adapted health care facility will involve delay, and delay puts the victims at greater risk. In such a situation, victims must receive the best stabilization possible in the field, allowing them to tolerate delayed arrival to hospital.

Field care cannot be improvised and must not be managed by untrained individuals. Well prepared organization is required, with the establishment of a specific treatment area. This treatment area, a front line, light medical structure, constitutes the Advance Medical Post.

#### *2.3.2 Location*

The Advance Medical Post must be established within walking distance (50 - 100 meters) of the impact zone:

- In a safe area;
- With direct access to the evacuation road;
- At a short distance from the Command Post;
- In a clear radio communication zone.

In some circumstances, for example at a site where hazardous materials are present, the AMP will be placed further away. But it must remain as close as safely possible to the impact zone. In such a situation, transport of victims from the impact zone to the AMP will require a different organization. If weather conditions allow (i.e., rain, sun, temperature, wind), the AMP can be in the open. It is preferable, if possible, to locate it in a building or under a tent.

#### *2.3.3 Role*

The main objective of the AMP is to provide effective field stabilization for victims of a mass casualty event. As outlined above (C.2.1.2), medical triage will take place at the entrance of the AMP in order to identify victims who will benefit from immediate attention.

Field stabilization care involves intubation, tracheostomy, chest drainage, drug treatment of shock, analgesia, fluid replacement, faciotomy, fracture immobilization, and dressing.

Another of the results, other than stabilization, expected from the care provided by AMP staff is to move as many patients as possible from the red to yellow category. The final role of the AMP is to organize patient transfer to adapted health care facilities.

---

**FIGURE 8. ADVANCED MEDICAL POST**  
**3-T Principle**

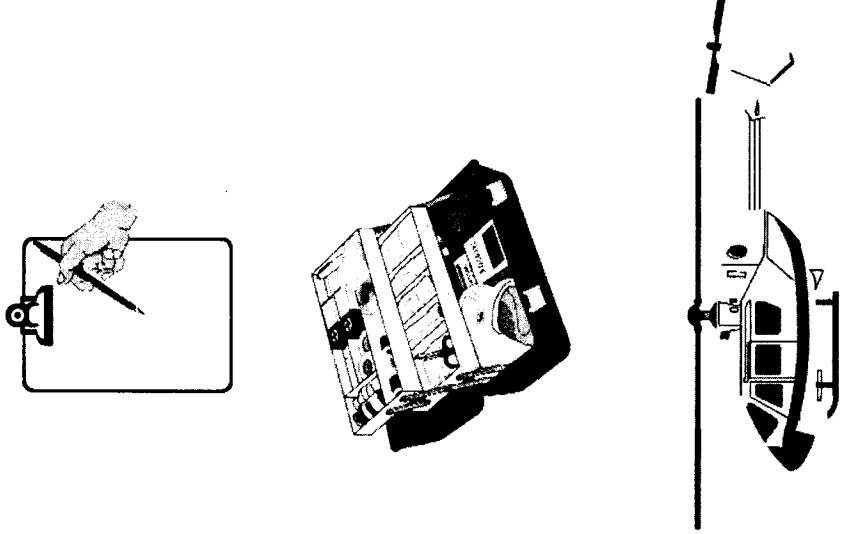
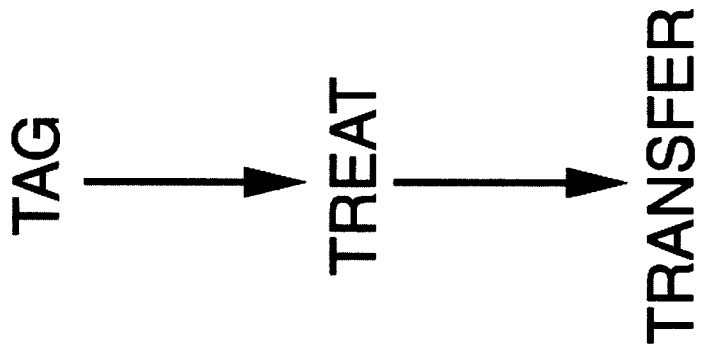

These functions can be represented by the three "T" rule: Tag, Treat, Transfer (see Figure 8).

#### 2.3.4 Personnel

In order to provide the level of care needed by victims in an Advance Medical Post, staff must be skilled medical personnel. The level of care provided here is similar to that expected from any hospital Accident and Emergency Department, and the most appropriate staff should be drawn from emergency physicians and nurses.

In most countries or communities, the hospital Accident and Emergency Department is likely to have immediately available at least one physician and nursing staff. These medical personnel must be available for immediate mobilization and will form the backbone of the Advance Medical Post.

This initial group in charge of establishing the AMP will be reinforced by other emergency physicians, anesthesiologists, surgeons and nursing staff as the momentum of the mobilization gathers. This hospital medical staff will be joined by paramedics, EMTs and first aiders.

#### 2.3.5 Organization of the Advance Medical Post

##### i. Internal Structure

###### *Design*

The design of the Basic Advance Medical Post (see Figure 9) includes:

- One entrance, easy to identify;
- A reception/triage area for the placement of a maximum of two victims simultaneously;
- A treatment area for 25 victims simultaneously, divided into:
  - Area for acute victims (i.e., Red and

Yellow tags); this will be the largest area, and

- Non-acute victims area (Green and Black tags);
- One exit.

The design of the Standard AMP (see Figure 10) includes:

- Two entrances (Acute - Non Acute), each entrance being easily identified by a red flag (for acute victims) and green flag (for non-acute victims);
- Two adjacent Reception/Triage Areas, interconnected to facilitate victim exchange.
- An Acute Treatment Area, linked to the acute triage area, divided into:
  - Red treatment area (immediately adjacent to triage area);
  - Yellow treatment area (following the red treatment area).
- A Non-Acute Treatment area, linked to non-acute triage area, divided into:
  - Black victims area (immediately adjacent to triage area);
  - Green treatment area (following the black victims area).

Each treatment area will be identified by a flag of appropriate color.

- An Evacuation Area: temporary waiting area for stabilized patients in transit to transfer.

###### *Surface Area*

The Advance Medical Post, being a "pass through" area, must not house many victims at one time. On an average, it should be able to accommodate 25 victims together with the AMP staff. Following are recommendations for the surface area required:

- Treatment and circulation require, as minimum field standard, 3 sq. yards (2.6 m<sup>2</sup>) per victim;
- Minimum area for triage is 10 sq. yards (8.3 m<sup>2</sup>), due to intense traffic;

FIGURE 9. BASIC ADVANCE MEDICAL POST

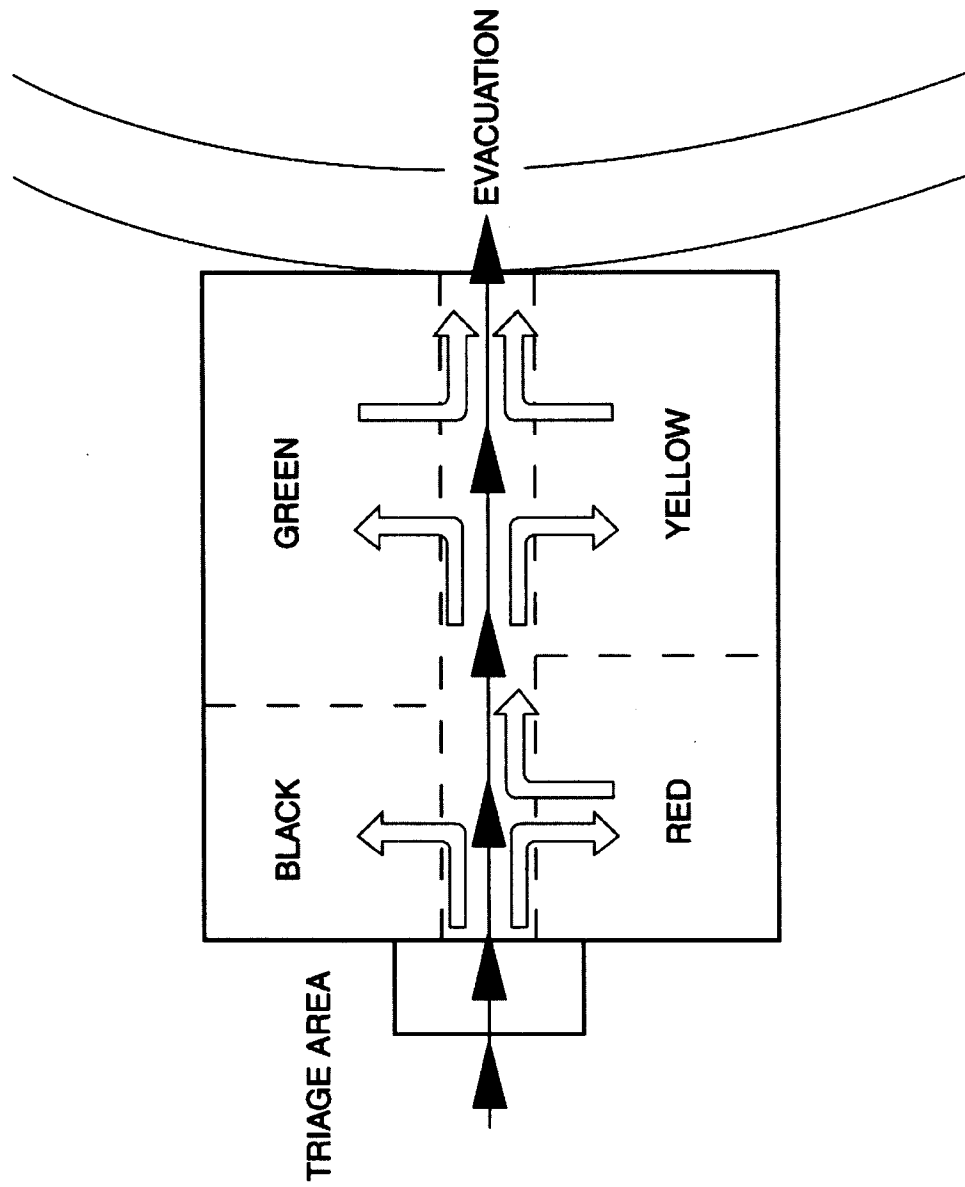
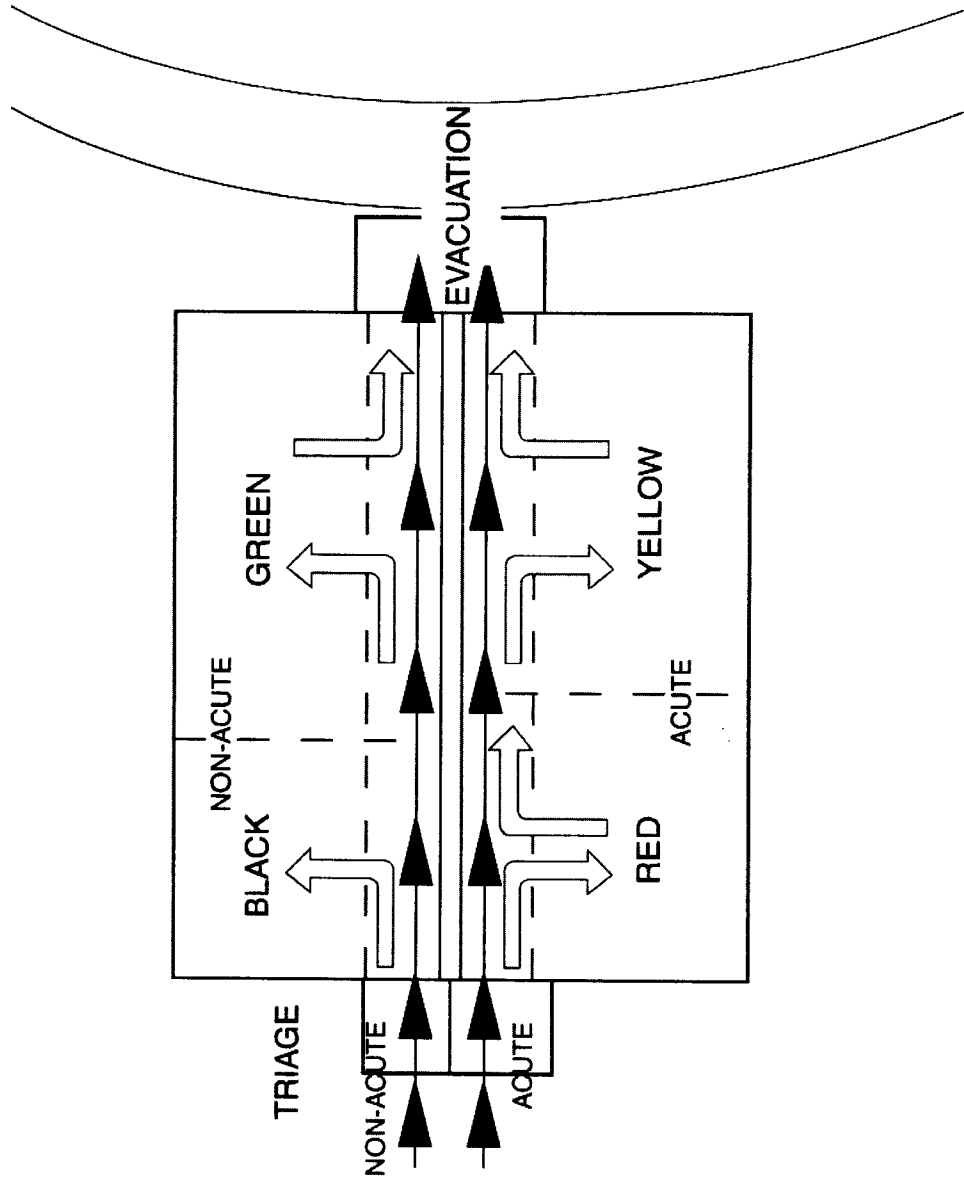

FIGURE 10. STANDARD ADVANCE MEDICAL POST



- Minimum area for basic AMP treatment areas is 75 sq. yards (65m<sup>2</sup>);
- Minimum area for standard AMP treatment areas is 150 sq. yards (130 m<sup>2</sup>);
- An evacuation waiting area will require 30 sq. yards (26 m<sup>2</sup>).

In general, the minimum area required for an AMP is approximately 85 sq. yards (73 m<sup>2</sup>).

#### ii. Victim flow

Victims carried by stretcher bearers will arrive at the appropriate triage entrance. The triage area must not house more than two victims at a time.

Victims will be tagged in RED/YELLOW/GREEN/BLACK. Registration will be done simultaneously and victims transferred to the appropriate treatment sub-area, where they will be stabilized.

Once stable, victims will progress to the evacuation area where registration of departure will be completed.

### 2.3.6 Personnel for Standard AMP

#### i. Triage Area (reception):

##### *Acute:*

- Triage Officer: most experienced physician (preference of experience: emergency physician, anesthesiologist, surgeon). No more than one person performs triage at one time;
- Assisted by either a nurse, an EMT or a first aider (in order of preference);
- Administrative Clerk for registration (clerk/nurse/first aider).

##### *Non-Acute:*

- Triage Officer: most experienced nurse, paramedic or EMT;
- Assisted by first aider;
- Administrative Clerk (possible duplicated in first aider).

In a basic AMP, a single triage team will operate for all victims. This team will be constituted as the above-mentioned acute triage team.

No treatment is to be done in the triage area.

#### ii. Treatment Areas

##### *Acute Treatment:*

- a. Acute Treatment Manager: preferably a skilled paramedic or EMT, experienced in disaster organization. If there are enough trained personnel available, an experienced physician might take this responsibility. This individual must be able to supply the area, coordinate with other areas, organize disposal, and manage radio communications. This individual will also act as the Manager of the AMP.
- b. Red Treatment Team:
  - Team Leader: Anesthesiologist, emergency physician or skilled paramedic;
  - Nurse/anaesthetist and/or Emergency Department nurse;
  - Assisted by EMT and/or first aiders;
  - Stretcher bearers.
- c. Yellow Treatment Team:
  - Team Leader: Nurse (Anaesthetist or Emergency Department) or paramedic;
  - Assisted by EMT and/or first aider;
  - Stretcher bearers.

*Non-Acute Treatment:*

- d. Green Treatment Team:
- Team Leader: most experienced EMT;
  - Assisted by EMT and/or first aider;
  - Stretcher bearers.
- e. Deceased (Black category) victims area: No personnel required.

## iii. Evacuation Area

- a. Leader: Paramedic/experienced EMT able to:
- Assess stability of patient's status;
  - Assess security of equipment;
  - Monitor briefly prior to transport;
  - Supervise loading;
  - Provide brief escort.
- b. Administrative Clerk
- c. Transport Officer: Senior officer from Fire or Ambulance Service. Liaises with the Manager of the AMP and the Command Post.

*2.3.7 Equipment (minimum requirement)*

## i. Triage Area

- Identification devices for area and officer
- Triage tags
- Clerical equipment
- Trestles (only four)
- Area lighting devices
- Sphygmomanometer/Stethoscope/Flashlight/Gloves

## ii. Acute Treatment Area (quantities required for a minimum of 25 patients):

- Identification devices for area manager (red jacket marked "Manager") and for each team leader (red/yellow arm bands)

- Area lighting devices
- Trestles
- Stretchers
- Blankets
- Clerical equipment
- Sphygmomanometer/Stethoscope/Flashlight/Gloves
- Medical disaster kit, including:
  - Airway equipment*, including:
    - Oxygen
    - Intubation set
    - Tracheostomy set
    - Chest tube set
    - Ventilation bag
  - Cardio-vascular equipment*, including:
    - Infusion set + fluid
    - Drugs for treatment of shock
    - MASTrousers
  - Electrical/pneumatic equipment*, including:
    - Suction
    - Specialized light
    - Cardioscope/defibrillator
    - Respirator
    - Batteries and/or generator
  - Dressing/Splint kit*, including:
    - Compresses, bands
    - Suture set
    - Gloves
    - Antiseptics
    - Survival blanket
    - Splints (including cervical collars)

## iii. Non-Acute Treatment Area

- Special lighting devices
- Dressing/splint
- Clerical equipment
- Stretchers
- Sphygmomanometer/Stethoscope/Flashlight/Gloves



#### iv. Evacuation Area

- Light
- Stretchers
- Clerical equipment
- Sphygmomanometer/Stethoscope/Flashlight/Gloves

#### 3. Evacuation Management Center (EMC)

When disaster situations have multiple impact zones, each requiring the establishment of an Advance Medical Post (AMP), an intermediate level is required to coordinate evacuation. If each AMP dispatches directly to the tertiary care center without such coordination, the result will be loss of efficiency.

To facilitate coordination, these multiple AMPs would dispatch to a center with greater stabilizing and evacuation facilities, which will coordinate the onward transfer. This may be a "field hospital", a polyclinic, a secondary hospital, or other ad hoc structures. This Evacuation Management Center (EMC) will:

- Collect/assemble all victims from attached AMPs;
- Reassess victims;
- Improve and/or follow stabilization;
- Dispatch victims.

#### D. FIELD MANAGEMENT PLAN

Figure 11 shows the general organization required in a field mass casualty situation.

# FIGURE 11. FIELD MASS CASUALTY MANAGEMENT

## General Organization

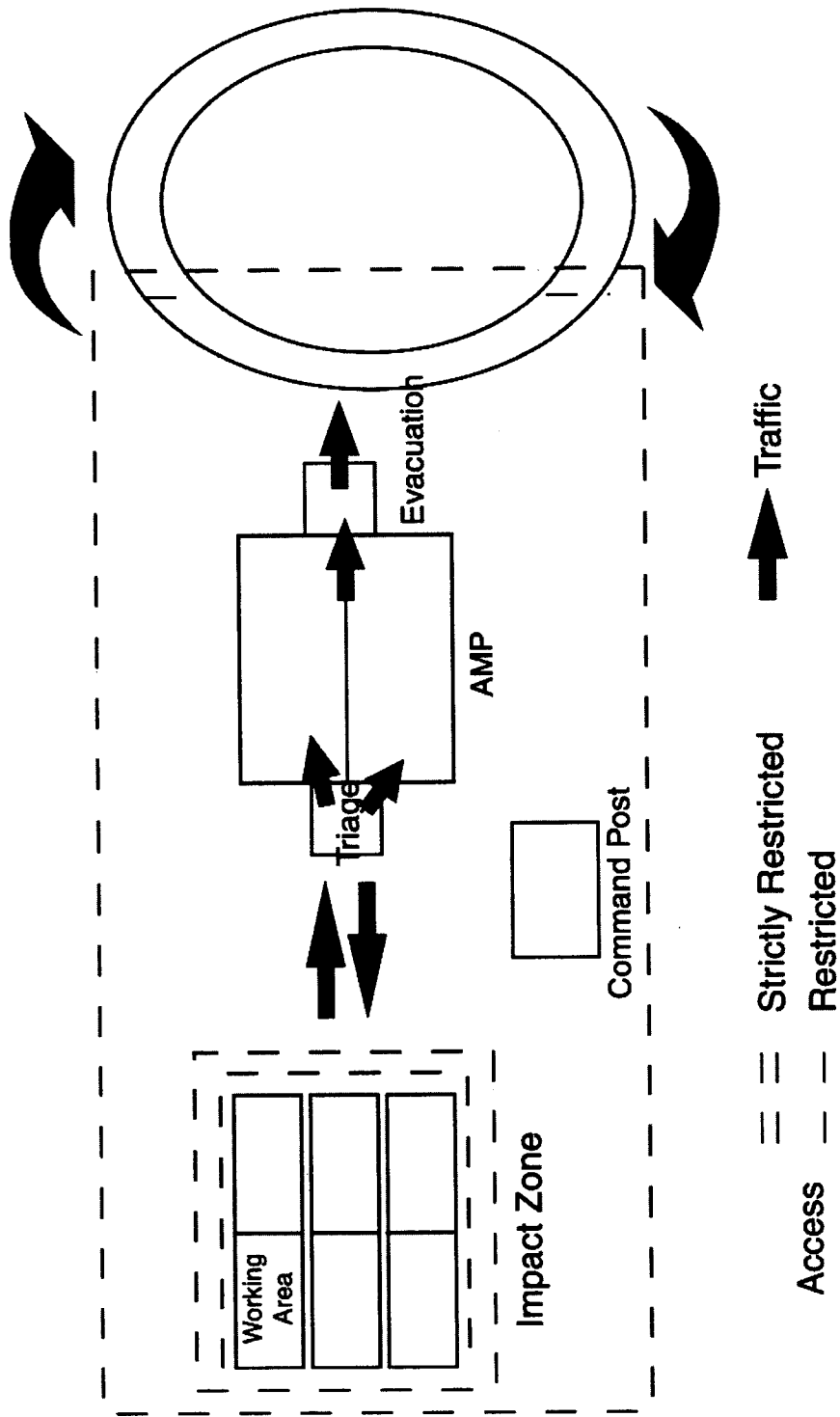

---

# 4. TRANSFER ORGANIZATION

## A. DEFINITION

The transfer organization includes those procedures implemented to ensure that victims of a mass casualty incident will be safely, quickly, and efficiently transferred by appropriate vehicles to the appropriate and prepared health care facilities.

## B. PREPARATION FOR EVACUATION

### 1. General Procedures

#### *1.1 Single Receiving Facility*

In the case that there is one receiving health care facility, there will be a direct link (by radio/phone) between the Acute Treatment Manager (ATM) and Accident and Emergency Department or hospital Command Post. The receiving hospital must maintain an active record of space available.

#### *1.2 Multiple Receiving Facilities*

In the case that there are multiple receiving facilities available, the Acute Treatment Manager will provide the Command Post Medical Officer with patient status and most appropriate care need (c.f. Evacuation Triage).

The Command Post Medical Officer (CPMO) will contact receiving facilities to confirm space available and inform of transfer. The Command Post Medical Officer will transmit destination to the Acute Treatment Manager.

The Acute Treatment Manager will then inform the Transport Officer of the following:

- Type of vehicle required
- Type of escort required
- Destination

The Transport Officer will notify the evacuation area of the required transport resource, if available. If the appropriate transport resources/escort are not available, the Transport Officer will propose alternative resources to ATM. If the team leader agrees on an alternative, then dispatch may proceed. If the team leader disagrees, the victim will continue to be monitored until an appropriate resource is available.

As each victim departs, the Transport Officer will inform the Command Post.

### 2. Preparation for Transport

The Evacuation Officer will:

- a. Assess the stability of the patient's status by monitoring pulse, B/P, breathing/ventilation, hemostasis. Any abnormality must be reported to ATM.
- b. Assess the security of the equipment, including:
  - Checking all tubes for correct positioning, and their ability to stay attached to the patient during the rigors of transfer. Deficiencies should be corrected where possible—if not, the ATM must be informed;

- Ensuring the efficiency of immobilization measures (e.g., collars, splints, etc.);
- Ensuring that triage tag is securely attached and clearly visible.

Short-term monitoring of victims may be necessary if the AMP treatment capacity is overloaded, and/or transport resources are not immediately available or are en route to the AMP, and/or if the receiving facility asks for delay. In such circumstances the Evacuation Officer maintains observation of the victims and informs ATM of any deterioration in their condition. This short-term monitoring should only be required in exceptional cases, as the evacuation area is supposed to serve only as a check point for victims before their departure.

## C. EVACUATION PROCEDURES

### 1. Regulation of Evacuation

#### *1.1 Principles*

Strict control of the rate/destination of evacuation is necessary to avoid overwhelming the health care facilities. One of the roles of the first responding team arriving on the scene will be to stop spontaneous evacuation organized by witnesses. This unmanaged transport in unsafe, uncontrolled conditions to any unprepared health care facility will endanger the lives of victims and disrupt the implementation of the Mass Casualty Management System—thus endangering the lives of those to follow.

#### *1.2 Rules*

No victim may be removed from AMP to health care facilities before:

- Victim is in most stable possible condition;
- The victim is adequately equipped for the transfer;
- The receiving health care facility is correctly informed and ready to receive the patient;
- The best possible vehicle and escort are available.

### 2. Control of Victim Flow

#### *2.1 The “Noria” Principle*

Patient movement (whether by walking, by stretcher, by vehicle) must be in a “one way” direction and without any crossing. From impact zone site to collecting point, from collecting point to AMP entrance, from AMP entrance to treatment area, from treatment area to evacuation area, from evacuation area to hospital receiving area, from hospital receiving area to appropriate care area, the victims will be on a kind of one-way “conveyor belt,” taking them from a basic first aid care level to sophisticated care level (see Figure 12).

In a mass casualty event, it will never be possible to have a transport resource for each victim. So, each transport level will have to use its own limited resources in a rotating system, to bring all patients from one level to the next. The efficiency of each successive transfer between levels will be maximized by ensuring that the circulation follows in a “one-way”, controlled rotation.

This one-way progression from level to level by rotating transportation resources was labelled “Noria” in 1916 during the World War I battle of Chemin de Dames in Verdun, France. “Noria” is a Spanish word that comes from Arabic, meaning “wheel”.

**FIGURE 12. VICTIM FLOW  
 “Conveyor Belt” Management**

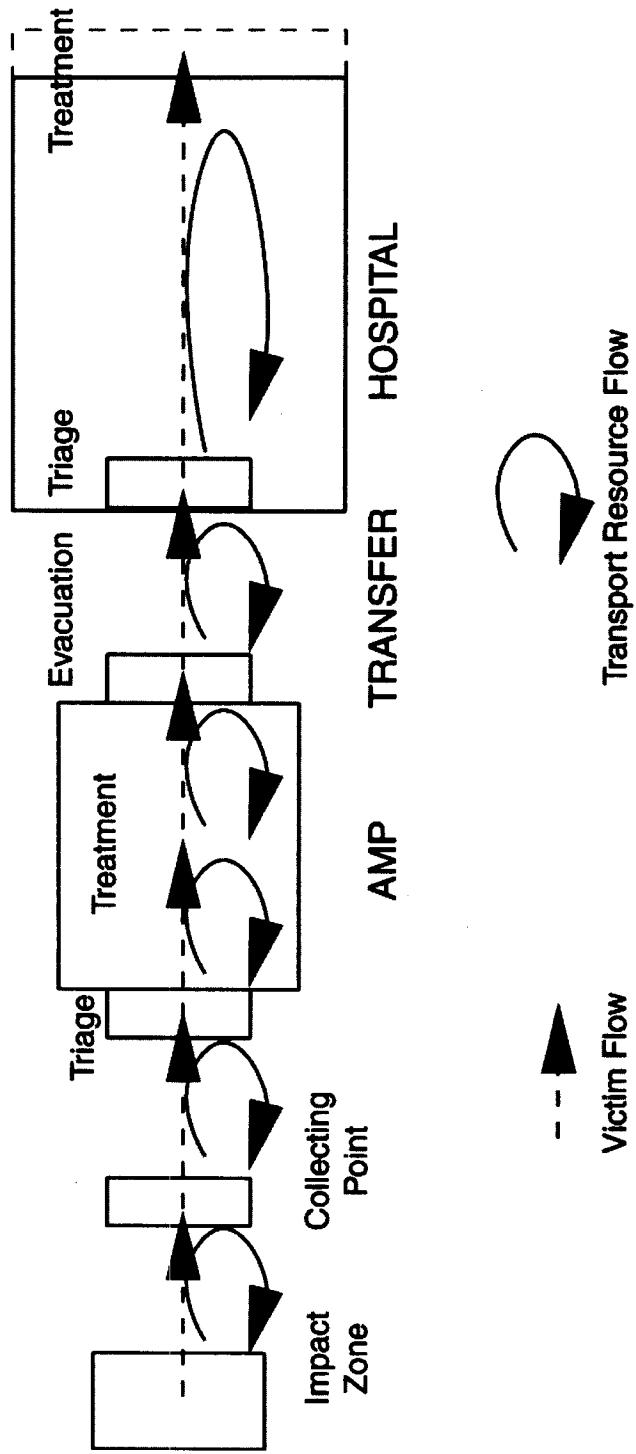

## 2.2 Ambulance Traffic Control

Smooth and efficient ambulance traffic requires:

### 2.2.1 Radio links

Radio links must be established between:

- Transport Officer at AMP;
- Hospital Accident and Emergency Department;
- Command Post;
- Ambulance Headquarters.

The Transport Officer must be aware of the exact location of each ambulance.

Five minutes before arrival at either Accident and Emergency Department or AMP the ambulance crew must inform the Accident and Emergency Department or Transport Officer.

### 2.2.2 Responsibility of ambulance driver

The driver will take orders only from the Transport Officer.

While on standby or during loading/unloading of victims, the driver must remain in the vehicle on radio watch. The driver must never leave the vehicle even to assist with the carrying of the patient.

The vehicle must be parked on standby in a specified area (designated by the Transport Officer) in such a way that the vehicle is accessible and clear to move.

## 2.3 Road Control

To facilitate the ambulance Noria, the central headquarters must organize, through the police, clear control of the access roads between hospitals and the AMP (e.g., crossing control).

The Advance Medical Post can request

from the Command Post that a specific patient (e.g., one with unstable internal bleeding) be sped along by "out riders".

## D. EVACUATION OF NON-ACUTE VICTIMS

---

Non-acute victims are evacuated only at the end of field operations. However, non-acute victim transfer can be inserted in the general evacuation process when:

- Primary health care facilities are available;
- Non-medical transport resources are available (e.g., minibus, pick-up truck);
- No interference will occur with transfer of acute victims (timing, manpower, roads).

This transfer will be coordinated by the Green Treatment Team Leader, the Evacuation Officer, the Transport Officer and the Command Post.

At all times, priority for evacuation must be given to acute victims.

Figure 13 is a checklist of the elements of field organization for mass casualty management.

## E. CASE STUDY

---

During an earthquake, a 33 year-old man, Mr. John Smith, is trapped in a collapsed building. We will follow this victim through the system.

The search and rescue team extricates Mr. Smith and reviewing injuries and status (thoracic trauma, abdominal trauma, crushed legs; conscious; breathing slightly laborious; pulse 100) classifies him as Acute (Red ribbon).

---

## FIGURE 13. MASS CASUALTY MANAGEMENT SYSTEM

### Field Organization Checklist

---

- ✓ SITUATION ASSESSMENT
- ✓ REPORT TO CENTRAL LEVEL
- ✓ WORKING AREAS PRE-IDENTIFICATION
- ✓ SAFETY
- ✓ COMMAND POST
- ✓ RADIO COMMUNICATIONS
- ✓ CROWD AND TRAFFIC CONTROL
- ✓ SEARCH AND RESCUE
- ✓ TRIAGE AND STABILIZATION
- ✓ CONTROLLED EVACUATIONS

Victim is transferred immediately to Advance Medical Post. He is triaged by Emergency Physician (BP 85/60, Pulse 120, RR 20, bilateral rhonchi) as Red.

Victim is received in Red Treatment Area where following takes place:

- Infusions (IV lines x 2)
- Oxygen
- No obvious rib fracture, bilateral rhonchi (lung contusion?)
- Abdomen: slightly tense x painful
- Fracture of left femur
- Compound fracture of the right tibia and fibula
- No dorsalis pedis pulse on right foot
- In spite of the rapid infusion of 2 liters, B/P remained at 85/60
- Abdomen tension increasing
- Diagnosis: suspicion of abdominal internal bleeding; crush syndrome to the right leg; suspicion of lung contusion.

Red Team Leader requests priority evacuation to surgical facility in equipped ambulance escorted by EMT.

The Acute Treatment Manager:

- Requests Command Post for identification of appropriate reception facility, according to victim status and Red Team Leader request.
- Contacts Transport Officer for identification of ambulance and escort (on standby).

Hospital identified 10 km from disaster site with operating theater and surgical team immediately available. Victim is assessed and secured in the ambulance by the Evacuation Officer and dispatched to the receiving hospital.

*Chronology:*

T+0	Incident
T+2 min	Warning
T+5 min	First Team at site
T+15 min	Victim located
T+18 min	Victim at AMP entrance
T+20 min	Victim at Red Treatment Area
T+30 min	Decision to evacuate
T+38 min	Victim in ambulance
T+45 min	Victim at hospital
T+55 min	Victim at operating theater

This time frame assumes the deployment in the field of the AMP as soon as the mass casualty event is declared.

This scenario emphasizes the need for rapid stabilization and appropriate dispatch of the victim according to the type of injury. Stabilization means not simply the establishment of infusion and immobilization but arresting deterioration or improving victim status.

In this scenario, the victim received stabilization care 20 minutes after the incident. If he had been extricated and sent directly to hospital, stabilization care would have started after 31 minutes, viz:

- 15 min (from incident to victim located)
- + 05 min (departure of ambulance)
- + 07 min (arrival at hospital)
- + 02 min (triage)
- + 02 min (care starts)

*TOTAL: 31 min*

Moreover, in the immediate evacuation approach, the victim is subjected to the physical stress of transport before being stabilized.



---

# 5. HOSPITAL ORGANIZATION

## A. INTRODUCTION

This chapter will describe the organization to be implemented in a hospital in order to respond to a mass casualty event. This organization, utilizing pre-established and tested procedures, will allow:

- Active mobilization and management of available resources (human and material);
- Links with pre-hospital organization;
- Management of in-patients and victim flow;
- Management of care;
- Management of secondary evacuations;
- Informing and updating authorities and relatives of victims.

Timely implementation of such an organization cannot be improvised and requires a well conducted preparatory phase including:

- Draft of a specific Hospital Mass Casualty Management Plan (HMCM), which forms part of the Hospital Disaster Response Plan as well as of the National Mass Casualty Management Plan;
- Dissemination of this HMCM plan to concerned persons and sectors (hospital staff, ministry of health, police, fire service, national disaster office);
- Regular testing and up-dating of the plan at hospital and multi-sectoral level.

At any time, any hospital must be able to respond, according to its capacities, to a mass casualty event.

## B. ACTIVATION OF HOSPITAL MASS CASUALTY MANAGEMENT PLAN

### 1. Alerting Process

The alert message originating from the dispatch center must be communicated directly to the Accident and Emergency Department (via hotline or radio). This message must be received personally only by the nurse in charge or physician on duty.

In collaboration with the administrative officer on duty (Administrative Nurse, Hospital Administrator, Hospital Medical Director), the decision to activate the HMCM will be made. At this time, the hospital telephone operator will begin to call persons on the established list.

### 2. Mobilization

#### *2.1 Hospital Mobile Disaster Team*

If the site of the event is within a twenty-minute radius, the hospital mobile disaster team shall proceed immediately to the scene. If the event is further than twenty minutes away, the hospital mobile disaster team will proceed to the site only at the request of the district health team.

In special circumstances likely to produce mass casualties (e.g., airport crash, fire on cruise ship) the hospital's mobile disaster team must be automatically dispatched to site.

## *2.2 Hospital Staff*

### *2.2.1 Key Staff*

Certain key persons must report to the hospital immediately (Hospital Administrator, Medical Superintendent, Matron, Stores Manager, Hospital Pharmacist, Housekeeper, Laundry staff, and all on-call staff).

### *2.2.2 Reinforcement Staff*

#### *Internal mobilization of Hospital Staff*

As the staff of the Accident and Emergency Department leave for the site, replacement staff from the hospital must be redeployed to the Accident and Emergency Department. Staff from other wards must assist staff clearing specific wards.

#### *Centripetal Mobilization of Hospital Staff*

Reinforcement of key departments, i.e., Accident and Emergency Department, Surgery, Operating Theater, Laboratory, X-Ray, Intensive Care Unit, must be effected and specific staff, e.g., orderlies, kitchen, laundry, maintenance, stores personnel, security and telephone operators must be summoned. For greater efficiency, reinforcement must be carefully planned and staggered to ensure a quick turnover of staff in the most exposed areas (e.g., Accident and Emergency Department, Operating Theater). This protects against staff burn-out during a mass casualty event and ensures prompt return to routine activities with adequate personnel.

## *2.3 Coordination with Other Sectors*

In accordance with the National Mass Casualty Management Plan, the hospital will coordinate with the following sectors:

### *2.3.1 Police*

The national Mass Casualty Management Plan must make provision for the automatic dispatch of an adequate police squad to the hospital as soon as a disaster is declared. This police squad will reinforce the security at the hospital with particular attention to securing the reception area and all the hospital entrances.

If within 15 minutes of the disaster notification the police squad has not reported to the hospital, the telephone operator must notify the dispatch center, the Emergency Operations Center, or the central Police Station.

### *2.3.2 Coordination with Red Cross*

The office of the Red Cross will send specifically trained volunteer teams to the hospital to be deployed in two teams, one for the Accident and Emergency Department and the other to be utilized wherever necessary.

### *2.3.3 Ham Radio Operators*

Ham radio operators will report to the hospital administrator and will deploy equipment as directed. The hospital administrator should contact the Red Cross office and the Ham Radio Association directly or through the Emergency Operations Center if these teams have not reported within 30 minutes of the disaster notification.

---

### 3. Hospital Command Post

In each hospital, a room should be identified to serve as the Hospital Command Post during a mass casualty event. This room should be pre-equipped with radio and telephone or be pre-fitted with the appropriate connections to facilitate immediate operation of radio and telephone communications. The room should be large enough to accommodate a maximum of ten persons and be easily identifiable.

The following persons will constitute the core of the Hospital Command Post:

- Hospital Administrator
- Medical Superintendent
- Matron
- Secretary
- Spokesperson (liaison with families and media)

### 4. Clearance of Receiving Facility

Beds should be made available in the hospital to accommodate victims of the mass casualty incident. The Hospital Command Post must initiate, immediately, pre-established procedures to clear in-patients who are able to be moved.

### 5. Estimate of Hospital Care Capacity

The reception capacity of a hospital is not only linked to the number of beds available, but to its capacity to deliver care. In a mass casualty event that produces trauma victims, the "bottleneck" of the care delivery system will definitely be the surgical and intensive care capacity of the receiving hospital (see Figure 14).

A multiple trauma victim will need, at minimum, two hours of surgical attention. The number of effective operating rooms (which includes availability of the room and sur-

geon, anaesthetist and equipment simultaneously) determines the surgical treatment capacity and thus the hospital care capacity.

If a hospital with three effective operating theaters receives twelve "red" victims needing prompt surgical attention during a mass casualty event, it will be able to treat, on an average, three patients every two hours. So, three of these twelve victims will have access to operating theaters six hours after their arrival at the hospital. This situation can severely endanger the life of these victims, if intensive care is not able to stabilize them.

Taking these limitations into consideration, it would then be more efficient to organize the rapid evacuation of these victims to health care facilities which would be able to provide appropriate care in a shorter time. Moreover, in such a situation, the Hospital Command Post must inform the Field Command Post that it cannot receive more "red" victims and that it is necessary to proceed to another health care facility.

## C. RECEPTION OF VICTIMS

---

### 1. Location

A reception area is where the hospital triage is conducted. The following requirements should be met:

- Direct access from the ambulance off-loading area;
  - Covered area;
  - Adequate lighting;
  - Easy access to key care sectors, e.g., Accident and Emergency Department, surgery, and ICU.
-

FIGURE 14. HOSPITAL DISASTER MANAGEMENT

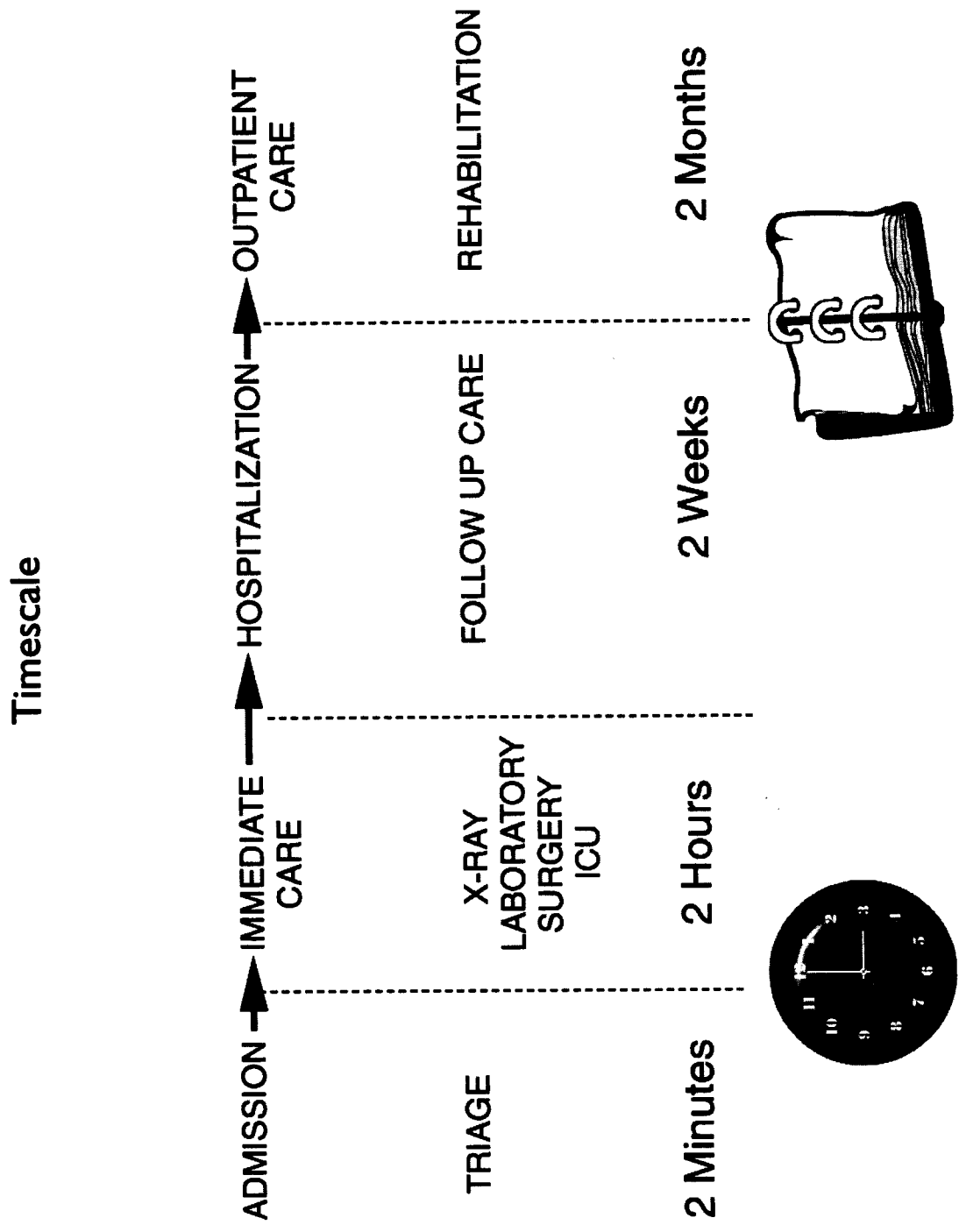

When pre-hospital victim management is efficient, the controlled flow of victims arriving at the hospital will allow, after triage, immediate dispatch of victims to the appropriate care area. However, if the pre-hospital management system fails and uncontrolled large numbers of victims arrive at the hospital, it will be necessary to hold patients after triage in a large room adjacent to the triage area, where victims will be stabilized and monitored before dispatch. Such a situation can overwhelm the hospital's capacity.

## 2. Personnel

The hospital triage officer will assess each victim in order to either confirm the evacuation triage or to recategorize. With efficient pre-hospital management, hospital triage could also be carried out by an experienced nurse from the emergency department.

If the pre-hospital management was not effective, an experienced emergency department physician or anesthesiologist should manage the hospital triage.

## 3. Links with the Field

In a well-established Mass Casualty Management System, constant communication must be maintained between the Hospital Command Post, the Advance Medical Post and the Field Command Post (see Figure 15).

In the hospital, there must be a constant flow of information between the hospital triage area and other key departments and the Hospital Command Post.

The ambulance will establish contact with the hospital triage area 5 minutes prior to arrival.

## D. HOSPITAL TREATMENT AREAS

### 1. Red Treatment Area

A minimum of two hours of surgical attention is necessary to treat a multiple trauma patient. In a country or province with a limited number of operating theaters, it will be impossible to provide simultaneous surgical care to victims requiring such care. Hence, it is necessary to have available a specific area where these "red" victims will receive appropriate attention. This area will be called the "red treatment area", should be managed by an anesthesiologist, and is best located in the Accident and Emergency Department which is already equipped and accustomed to managing acute patients.

### 2. Yellow Treatment Area

Victims tagged in the yellow category will be sent immediately after triage to a surgical ward which has been cleared during the activation phase for that purpose. This area will be managed by a hospital physician.

The victim's status must be continuously monitored, reassessed, and stabilization maintained. If the victim's status worsens, he or she must be transferred to the "red" area.

### 3. Green Treatment Area

Green coded patients should not be transferred to the main hospital, but referred to health centers or clinics. However, when the pre-hospital management system fails, many "green" victims will arrive at the hospital. Therefore, provision must be made in hospital mass casualty management plans for a holding area for this category of victim. This area is best located away from the other care

FIGURE 15. RADIOCOMMUNICATION NETWORK

Field - Hospital

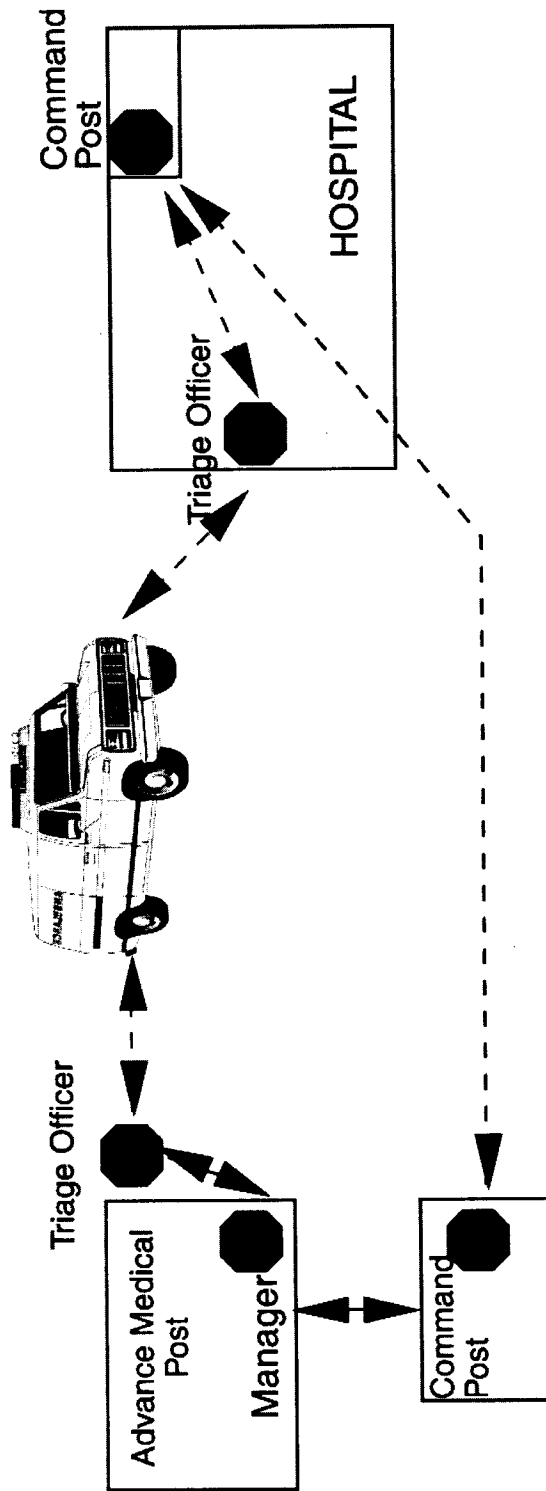

areas. Whenever possible, these victims should be transferred to a nearby health center/clinic.

#### 4. Hopeless Victim Area

These patients, needing only supportive care, are most appropriately held in a medical ward, previously cleared during the activation phase.

#### 5. Deceased (Black Category) Victims Area

Space large enough to accommodate a minimum of ten bodies in acceptable conditions should be identified in the Hospital Mass Casualty Management plan.

### E. SECONDARY EVACUATION

Under certain circumstances, such as when the hospital capacity is overwhelmed, or a victim requires highly specialized care (e.g., neurosurgery), transfer to more appropriate care facilities will be necessary. This can be to another hospital in the same area, to another district or province, or might include overseas evacuation.

The Hospital Command Post transmits requests for evacuation to the Medical Officer in the Emergency Operations Center who will make the necessary contacts and organize the transfer.

### F. CASE STUDY (Continued)

Mr. John Smith arrived at the hospital triage area where he was assessed by the hospital triage officer who confirmed his status as a "red" category victim as determined by the evacuation officer of the Advance Medical Post. This patient required immediate surgical care (for internal abdominal bleeding and crush syndrome).

The officer in charge of the hospital triage contacted the Hospital Command Post requesting immediate access to the operating theater. This being possible, Mr. Smith was immediately transferred to the operating theater. While the anesthesiologist was preparing him for surgery, blood samples were sent to the laboratory requesting standard blood tests and blood prepared for transfusion.

Mr. Smith underwent surgical amputation of the right leg and splenectomy for a ruptured spleen.

It was noted that in spite of fluid replacement, no urine had been passed since admission to the Advance Medical Post. A diagnosis of acute renal failure secondary to crush syndrome and massive hemorrhage was made.

No facilities being available for renal dialysis, the anesthesiologist communicated a request to the Hospital Command Post for transfer to an appropriate facility.

The Hospital Command Post contacted the Emergency Operations Center (EOC) requesting evacuation. The medical officer at the EOC received the information with appropriate details and made enquiries of neighboring facilities. The University Hospital of a neighboring country agreed to admit this patient to its acute dialysis unit. The medical officer at the EOC then request-

ed assistance from the National Disaster Coordinator to organize transportation of the victim.

Three hours after the request for evacuation, Mr. John Smith was transferred from the hospital red treatment area to the hospital helipad and airlifted with medical escort to the receiving hospital where he arrived forty minutes later.

## **G. HOSPITAL MANAGEMENT GENERAL SCHEME**

---

Figure 16 shows the flow of victims through the hospital mass casualty system.

---



**FIGURE 16. HOSPITAL RECEPTION**  
Flow of Victims

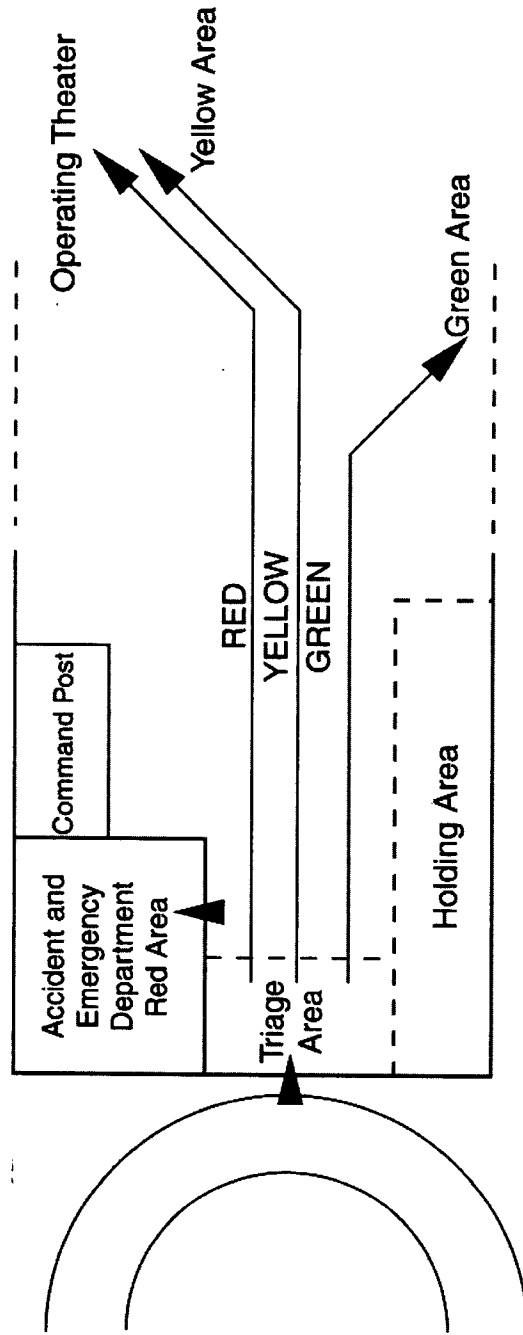

---

## 6. NATIONAL MASS CASUALTY MANAGEMENT PLAN

### A. NATIONAL RESPONSE TO MASS CASUALTY EVENTS

---

A National Mass Casualty Management Plan is a component of the National Disaster Response Plan, but can function as an autonomous plan.

In an extensive disaster involving mass casualties, the National Disaster Response Plan will be activated with its mass casualty component. In case of a serious mass casualty event which is limited to a localized geographic area (e.g., airport crash), only the Mass Casualty Management Plan component of the National Disaster Response Plan will be activated.

If the extent of the mass casualty event does not require the activation of the entire National Mass Casualty Management Plan (e.g., bus crash involving twenty victims), the rescue organization must follow the procedures outlined for the Mass Casualty Management System. In this situation, the activation of the Emergency Operations Center is not mandatory.

Each nation or territory will define, in the introduction to its Mass Casualty Management Plan, what constitutes a limited mass casualty event and a large mass casualty event.

### B. DISTRICT RESPONSE TO MASS CASUALTY EVENTS

---

A district can generally be described as an administrative or geographic division of a territory, the center of which is the most populous township which is generally served by a Police Station, a Fire Station and main Health Center. In mass casualty events occurring at some distance from the central level, the district staff will be the first group of persons to respond.

Each district will have to respond immediately with its own resources to a mass casualty event. It may be necessary to maintain this response for prolonged periods if populations are isolated (as in the case of flooding or landslides). Therefore, each district must develop in coordination with the central level its own Mass Casualty Management Plan as a component of the National Mass Casualty Management Plan.

The involvement of the entire community is essential if there is to be an efficient district response. Hence, any district plan must seek to mobilize and coordinate community resources.

---

## 7. ASSISTANCE FROM NEIGHBORING COUNTRIES OR TERRITORIES

A mass casualty event is likely to overwhelm a community that has only limited resources. Plans and procedures should be established to identify and list sources of external assistance. Neighboring facilities must be identified, canvassed and enumerated. Account must be taken of the possibility that these facilities will also be over extended. Therefore, contingencies should be sufficient to account for the worst possible circumstances.

Neighboring countries or territories should be approached and their agreement sought for mutual support. If international borders are crossed, the Foreign Affairs Ministries should be involved in the agreements.

### A. MOBILIZATION

---

With proper and sufficient plans for assistance established, accounting for the broadest spectrum of situations, the type of assistance required must be clearly defined. The decision to seek external assistance must be taken as soon as possible taking into account the best interest of the victims and the outside resources being called upon.

When external assistance is necessary, the EOC will issue the request to the potential responder (countries or territories, regional and/or international organizations). To facilitate this request/response process, formal protocols should be adopted with neighboring countries or territories and with key regional and/or international agencies.

All requests for external assistance emanating from various sectors, agencies or national organizations must be channelled through the EOC. To bypass this essential coordination hub only adds to the confusion.

### B. INTEGRATION OF EXTERNAL STAFF

---

Assisting countries/organizations must ensure that personnel sent correspond to requested specifications. Arriving teams must report directly to the EOC from whence they will be dispatched to a specific sector leader for assignment. Any external team must be integrated into the local response and operate under local coordination consistent with local procedures.

To facilitate smooth integration of external teams, regional standardization of disaster response procedures and joint regional training is recommended.

---

# 8. IMPLEMENTATION OF A MASS CASUALTY MANAGEMENT SYSTEM

The implementation of a Mass Casualty Management System must follow a well-defined process, planned and managed jointly by the National Disaster Coordinator and the Health Disaster Coordinator.

## A. PHASE 1- ADOPTION AS NATIONAL POLICY

---

The Ministry of Health will function as a catalyst in the process and will assume the responsibility of presenting the objectives and principles of the Mass Casualty Management System to the political directorate of the country. Phase 2 of the implementation process will commence as soon as the decision is taken to:

- Incorporate this response strategy into the National Disaster Policy;
- Endorse the proposed implementation process.

## B. PHASE 2 - SENSITIZATION

---

Sensitization at all levels and in all sectors is imperative for the successful implementation of the Mass Casualty Management System. The National Disaster Coordinator and the Health Disaster Coordinator share responsibility for sensitization which can be achieved through the following steps:

### 1. National Consultation

A one-day meeting of decision makers and managers (from the public and private sectors) at which national policy will be enunciated and the outline of the system introduced. The aim of this consultation is to foster general consensus and commitment.

### 2. Sectoral Consultation

Within each sector, vertical consultations will be organized to present the Mass Casualty Management System and define the specific role of each sector within the system. The aim is to obtain consensus from each sector regarding its role and the linkages with the other sectors.

### 3. Multisectoral Consultation

Multisectoral consultation brings together management staff of all involved sectors with the objective of obtaining consensus for the multisectoral approach and commitment to an implementation agenda.

### 4. Community Sensitization

Representatives of community groups and non-governmental organizations will be invited to the national consultation. Broad sensitization of the community will occur simultaneously with the implementation process through the media and other community communication channels. The community will be integrally involved in the

development of the district component of the National Mass Casualty Management Plan.

### C. PHASE 3 - TRAINING

---

Training should be conducted utilizing a multisectoral approach. A core of persons from relevant sectors will be trained as mass casualty managers through a series of workshops and small exercises. Each manager will be individually responsible for training of the staff in his/her sector. In case of a mass casualty event, those core persons will function as the managers of their specific teams.

A national mass casualty management exercise will be organized as soon as a basic level of preparedness exists in order to strengthen the linkages between sectors and for practical application, to evaluate the implementation.

Training in Crisis Management will be conducted for politicians and top level managers.

### D. INSTITUTIONALIZATION OF THE SYSTEM

---

Sustainability of the Mass Casualty Management System relies on the degree of institutionalization. Each country/territory should ensure that several basic actions are taken. Given the limited resources available in countries in some regions, it is highly advisable to utilize a common approach within the region.

#### 1. National Emergency Act

Regulations under this Act should incorporate the defined role of the key managers of the Mass Casualty Management System (see Annex 1).

#### 2. Job Description

The responsibility of each officer in Mass Casualty Management should be included in his or her standard job description, which will also detail minimum requirements to fulfill this function (see Annex 2).

#### 3. Training

All physicians, nurses, Police Officers, Fire Officers, and other emergency responders must be trained in Mass Casualty Management before their graduation or official assignment to work. All related schools and training institutions must incorporate Mass Casualty Management training into their curricula.

Annual training sessions with drills must be organized at various levels. This is aimed at upgrading the level of knowledge and maintaining the state of readiness.

Emergency services must observe minimum requirements and be able to function as defined at the regional level.

Main district health care facilities and Accident and Emergency Departments should be equipped with sufficient emergency medical kits containing equipment and supplies for treating a minimum of 25 casualties.

### E. MAINTENANCE OF A MASS CASUALTY MANAGEMENT SYSTEM

---

The Mass Casualty Management System must be evaluated annually through a simulation exercise which will take place as part of the annual training. Every two years, this exercise will constitute a component of a national simulation exercise, organized to test the National Disaster Response Plan.

In the event of a large mass casualty incident during the year, the annual simulation exercise will be replaced by a debriefing/evaluation session.

The National Disaster Coordinator, with the direct support of the Health Disaster

Coordinator has overall responsibility for the management of the system. The Ministry of Health, through the Health Disaster Coordinator, has the added responsibility of ensuring the highest quality of care delivery.

---

## ACTION CARDS

---

- |                                 |                                   |
|---------------------------------|-----------------------------------|
| 1. OPERATOR - DISPATCH CENTER   | 10. ACUTE TREATMENT MANAGER       |
| 2. INITIAL ASSESSMENT TEAM      | (MANAGER OF ADVANCE MEDICAL       |
| 3. FIRE SERVICES                | POST)                             |
| 4. SEARCH AND RESCUE TEAM       | 11. MEDICAL TRIAGE OFFICER        |
| 5. SEARCH AND RESCUE OFFICER    | 12. RED TEAM LEADER               |
| 6. COORDINATOR OF THE COMMAND   | 13. EVACUATION OFFICER            |
| POST                            | 14. TRANSPORT OFFICER             |
| 7. FIRE OFFICER IN COMMAND POST | 15. ADMINISTRATION CLERK - TRIAGE |
| 8. POLICE OFFICER IN COMMAND    | AREA                              |
| POST                            | 16. ADMINISTRATION CLERK -        |
| 9. HEALTH OFFICER IN COMMAND    | EVACUATION AREA                   |
| POST                            | 17. AMBULANCE DRIVER              |
-

**Action card****1. OPERATOR - DISPATCH CENTER**

- Receives initial call or warning message concerning the event
- Establishes:
  - caller's name and telephone number
  - nature of event
  - exact location of event
  - time of occurrence
  - approximate number of victims
- Verifies information (if an unqualified observer)
- Mobilizes and sends a dispatch team to site for initial assessment
- Alerts potential responders (stand by)
- Receives report of initial assessment
- Dispatches necessary resources

**Action card****2. INITIAL ASSESSMENT TEAM**

- Travel to site expeditiously
  - Identify a leader
  - Establishes:
    - precise location of the event
    - time of the event
    - type of incident
  - Estimates:
    - number of casualties
    - added potential risk
    - exposed population
  - Team Leader reports initial information to dispatch center
  - Draws a single map of the area indicating:
    - main topographical features
    - potential risk areas
    - victims
    - access roads
    - various field areas
    - limits of restricted area
    - compass rose
    - wind direction
  - Directs resources arriving in the field until the arrival of a high ranking officer
  - Hands over the map and briefs first arriving officer of rank
  - Reports to reassigned station
-



## Action card

**3. FIRE SERVICES**

The Fire Services will be responsible for:

- safety
- search and rescue
- risk reduction
- definition of restricted areas
- providing a senior officer as a staff member of the Command Post
- providing the AMP with a Transport Officer

## Action card

**4. SEARCH AND RESCUE TEAM**

- Locates victims
- Removes victims from unsafe locations to collection point if necessary
- Conducts initial triage of victims (acute/non-acute)
- Provides essential first aid
- Transfers victims to Advance Medical Post

## Action card

**5. SEARCH AND RESCUE OFFICER**

- Coordinates search and rescue activities by:
  - identifying and assigning teams
  - supervising team functioning
  - establishing a collection point when necessary
  - coordinating the transfer of patients from the collection point to the Advance Medical Post
  - communicating with Command Post for resource reinforcement
  - ensuring safety and welfare of search and rescue teams

## Action card

**6. COORDINATOR OF THE COMMAND POST**

- Performs overall coordination of the field operations
- Receives reports from the other officers in the Command Post
- Continuously assesses the general situation
- Coordinates requests between sectors in field
- Ensures links between sectors
- Ensures the welfare of all staff involved in field operations
- Liaises with central headquarters, (e.g., EOCs)
- Authorizes releases to the media
- Acts as link between field operation and backup system
- Ensures adequate radio communication

**Action card****7. FIRE OFFICER IN COMMAND POST**

- Coordinates activities of the Fire Service in the field (ensures safety, search and rescue)
- Assists in transport organization
- Manages fire staff resource needs by:
  - continuous assessment
  - requests for backup
  - timely rotation of staff
  - withdrawal of staff no longer needed
- Reports to the coordinator of the Command Post

**Action card****9. HEALTH OFFICER IN COMMAND POST**

- Supervises the field care of victims
- Provides the link between the health/medical backup system
- Ensures the adequate supply of manpower and equipment
- Receives reports from the manager of the Advance Medical Post (acute treatment manager)
- Deploys and manages health staff resources
- Reports to the coordinator of the Command Post

**Action card****8. POLICE OFFICER IN COMMAND POST**

- Ensures that radio communication is established and maintained
  - Implements security measures to:
    - maintain restricted areas
    - provide crowd and traffic control
  - Manages field police resources by:
    - continuous assessment of needs
    - redeployment of police officers
    - requests for backup
    - ensure adequate supply of necessary equipment
  - Generally is the coordinator of the Command Post
-

## Action card

**10. ACUTE TREATMENT MANAGER  
(MANAGER OF ADVANCE  
MEDICAL POST—AMP)**

- Supervises triage and stabilization of victims in AMP
- Establishes the internal organization of the AMP
- Manages the staff of the AMP
- Ensures that effective victim flow is maintained
- Ensures adequate equipment and supplies are available in each treatment area
- In collaboration with the Transport Officer, the Health Officer in the Command Post, and receiving health care facility, organizes the transfer of patients to health care facilities
- Decides on the order of transfer victims, the mode of transport, escort and place of transfer
- Ensures staff welfare
- Reports to the Health Officer in the Command Post

## Action card

**11. MEDICAL TRIAGE OFFICER**

- Receives victims at the entrance of the AMP
- Examines and assesses the condition of each victim
- Categorizes and tags patients as follows:  
*Red* - immediate stabilization necessary  
*Yellow*- close monitoring, care can be delayed  
*Green* - minor delayed treatment or no treatment  
*Black* - deaths
- Directs victim to appropriate treatment area
- Reports to the manager of the AMP

## Action card

**12. RED TEAM LEADER**

- Receives patient from medical triage
- Examines and assesses the medical condition of the victim
- Institutes measures to stabilize the victim
- Continuously monitors victim's condition
- Reassesses and transfers victims to other treatment areas
- Prioritizes victims for evacuation
- Requests evacuation in accordance with priority list
- Reports to the manager of the AMP

## Action card

**13. EVACUATION OFFICER**

- Receives victims for evacuation
- Assesses the victim's stability
- Assesses the security of any equipment attached to victims and corrects deficiencies
- Ensures that immobilization is adequate
- Ensures that the tag is safely and clearly attached
- Maintains observation of victims until transported
- Supervises loading and ensures escort is briefed
- Reports to manager of AMP

## Action card

**14. TRANSPORT OFFICER**

- Coordinates and supervises the transportation of victims
- Identifies access routes and communicates traffic flow to drivers
- Supervises all available ambulance drivers and drivers of assigned vehicles
- Receives requests for transportation
- Assigns appropriate vehicle tasks in accordance with specific needs
- Maintains a log of the whereabouts of all vehicles under his/her control
- Reports to the manager of the AMP

## Action card

**15. ADMINISTRATION CLERK -  
TRIAGE AREA**

- Maintains a register of all victims admitted to medical triage
- Records:
  - name or identification number
  - age when possible
  - sex
  - time of arrival
  - injury category assigned
- Reports to Triage Officer

## Action card

**16. ADMINISTRATION CLERK -  
EVACUATION AREA**

- Maintains a register of all victims leaving the AMP
- Records
  - victim name/number
  - injury category
  - time of departure
  - mode of departure (vehicle) and escort
  - destination
- Reports to the evacuation office

## Action card

**17. AMBULANCE DRIVER**

- Remains in the vehicle at all times
- Responds promptly to directives from Transport Officer
- Ensures that vehicle is parked in designated area, and is ready to move
- Transports patients in accordance with safety rules and instructions
- Reports to Transport Officer

## STANDARD JOB PROFILES

---

- |                                      |                                     |
|--------------------------------------|-------------------------------------|
| 1. COORDINATOR - COMMAND POST        | 5. FIELD TRIAGE OFFICER - NON ACUTE |
| 2. MEDICAL OFFICER - COMMAND POST    | AREA                                |
| 3. MANAGER - ADVANCE MEDICAL POST    | 6. EVACUATION OFFICER               |
| 4. FIELD TRIAGE OFFICER - ACUTE AREA | 7. TRANSPORT OFFICER                |
|                                      | 8. SEARCH AND RESCUE OFFICER        |
-

**1. COORDINATOR - COMMAND POST**

- Police Officer of high rank
- Trained in Mass Casualty Management
- Skilled in radiocommunications network
- Skilled in traffic control
- Sound knowledge of safety/security
- Skilled in Field Operations
- Skilled in Staff/Resource Management

**2. MEDICAL OFFICER - COMMAND POST**

- Physician or nurse (e.g. District Medical Officer or District Nurse)
- Trained in Mass Casualty Management
- Skilled in Staff Resource Management
- Skilled in radiocommunications
- Skilled in Field Operations
- Sound knowledge of Health Sector Resources
- Sound knowledge of Health Sector Organization

**3. MANAGER - ADVANCE MEDICAL POST**

- Nurse/Paramedic/EMT or Physician
- Trained in Mass Casualty Management
- Skilled in pre-hospital care management
- Skilled in staff management
- Skilled in radiocommunications
- Skilled in logistical operations
- Sound knowledge of country's Health Care Resources

**4. FIELD TRIAGE OFFICER - ACUTE AREA**

- Emergency physician
- Trained in Mass Casualty Management
- Skilled in Field Operation
- Skilled in Field Care
- Sound knowledge of country's Health Care Resources

**5. FIELD TRIAGE OFFICER - NON ACUTE AREA**

- Nurse/Paramedic/EMT
  - Trained in Mass Casualty Management
  - Skilled in Field Care
  - Skilled in Field Operations
-

**6. EVACUATION OFFICER**

- Paramedic/EMT or Physician
- Trained in Mass Casualty Management
- Skilled in medical transport/evacuation
- Sound knowledge of Health Care Facilities
- Sound knowledge of transport management

**8. SEARCH AND RESCUE OFFICER**

- Fire Officer
- Trained in search and rescue techniques
- Trained in safety operations
- Trained in Mass Casualty Management
- Skilled in Staff Management
- Skilled in Field Operations

**7. TRANSPORT OFFICER**

- Fire Officer/Police Officer/Ambulance Service Officer
- Trained in Mass Casualty Management
- Skilled in Ambulance Traffic Control
- Skilled in radiocommunications
- Sound knowledge of country's transport resources
- Sound knowledge of access routes to Health Care Facilities

---

# BIBLIOGRAPHY

- Butman, A.M., *Responding to the Mass Casualty Incident*. A Guide for EMS Personnel. Akron, Ohio: Emergency Training, 1982.
- Canada, Ministry of National Health and Welfare, Report of the Sub-Committee on Institutional Program Guidelines, *Pre-Hospital Emergency Care Services*, 1985.
- De Boer, J., Baillie, T.W., *Disasters - Medical Organization*. Oxford: Pergamon Press, 1980.
- Garcia, L. Malm, *Disaster Nursing*, Rockville, Md: Aspen Publications, 1985.
- Hafen, B.Q., Karren, K.J., Petersen, R.A., *Pre-Hospital Emergency Care and Crisis Intervention Workbook*, 3rd edition, Englewood, Colo.: Morzon Publishing Co., 1989.
- Noto, R., Hugwenard, P., Larcen, A., *Médecine de Catastrophe*, Paris: Editions Masson, 1987.
- Pons, J. *Mémento de Chirurgie de Guerre*. Paris: Editions ORA/GEF; 1984.
- Savage, P.E.A., *Disasters - Hospital Planning*, Oxford: Pergamon Press Ltd., 1973.
- Seaman, J., *Epidemiology of Natural Disasters*, Basel, Switzerland: S. Karger, 1984.
- Spirgi, R., *Manual de Atención Médica de Emergencia*. Madrid: Ministerio de Sanidad y Consumo, Secretaría General Técnica.



When an accident or disaster involving large numbers of injuries occurs, the first to provide emergency assistance are communities closest to the site of the incident. During the last 20 years the Caribbean and Latin America have given special attention to training emergency personnel in triage and in providing first aid either at the site of an accident or disaster, or at the hospital. The entire Region is now familiar with methods of classifying casualties, and this process has proved to be the most efficient means of ensuring survival of the injured in a mass casualty situation. However, there are still serious gaps in the coordination process, a situation that is most pronounced in remote areas or those with limited resources.

Many lives have been lost in mass casualty situations because resources were not mobilized efficiently. The challenge we face is this: the more scarce the resources, the more efficient the organization must be. This publication describes the steps to designing a mass casualty management system that will ensure the highest possible survival rate. It focuses on the involvement of police, firefighters, Red Cross volunteers, health center and hospital staff. If these professionals form part of the structure that we refer to as the mass casualty management "system" in this publication, they can positively contribute to saving lives.

**This publication can be consulted on the Internet at:  
[www.paho.org/english/ped/masscas.htm](http://www.paho.org/english/ped/masscas.htm)**



**PAN AMERICAN HEALTH ORGANIZATION**  
**Pan American Sanitary Bureau, Regional Office of the**  
**WORLD HEALTH ORGANIZATION**  
**525 Twenty-third Street, N.W.**  
**Washington, D.C. 20037, U.S.A.**

**disaster-publications@paho.org**  
**[www.paho.org/disasters/](http://www.paho.org/disasters/)**